



Metallurgica Irpina spa

FILO ZINCATO - PALETTI - RETI METALLICHE



FENCING AND BUILDING SOLUTIONS





La Metallurgica Irpina Spa è stata fondata più di 15 anni fa con lo scopo di produrre e commercializzare **filo zincato**, **paletti** e **reti metalliche**, oltre a tutta la gamma dei derivati vergella e accessori.

L'azienda è situata in località Ariano Irpino, in provincia di Avellino, e ricopre un'area di circa 9000 metri quadrati riservati in parte ad Uffici commerciali ed in parte adibiti a Depositi; il punto di forza della Metallurgica Irpina Spa è quello di offrire diverse soluzioni ai suoi molteplici clienti proponendo articoli che spaziano dal settore Ferramenta, Edilizia, Recinzioni, Siderurgia e Agricoltura.



L'incremento costante delle vendite ha portato nel corso degli anni allo sviluppo di nuove unità produttive a **Teramo** specializzata nella produzione di reti zincate e plastificate, pannelli sia mobili che fissi; ad **Avellino** dove è concentrata l'intera produzione di reti elettrosaldate, griglie zincate e plastificate, filo plastificato, pannelli mobili, pali per vigneti e **Lucera** dove è concentrata la produzione di gabbioni, materassi e rete paramassi.



La politica aziendale è sempre stata e sarà quella di seguire e soddisfare le esigenze di mercato puntando alla soddisfazione del cliente, piccolo, medio o grande che sia; tale prospettiva considerata da un punto di vista sia qualitativo sia di servizio rapido ed efficiente ha portato ad estendere la Rete Vendita su tutto il territorio nazionale con depositi e piattaforme logistiche distribuiti in punti strategici dell'Italia, quali Grosseto, Teramo, Lucera, Ariano Irpino, Caltanissetta e Sassari.



La Metallurgica Irpina Group continua comunque ad avere ambizioni di crescita cercando di investire in nuove figure professionali, in sviluppo tecnologico ed innovazione nonché rimane sempre attenta e propensa all'inserimento di nuovi Prodotti per arricchire ulteriormente la vasta gamma già esistente.



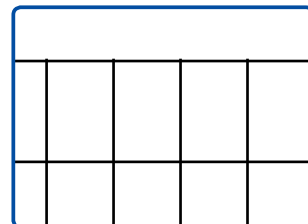
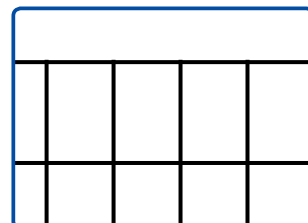
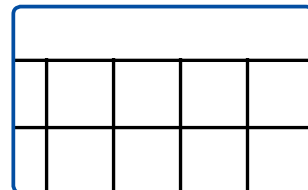
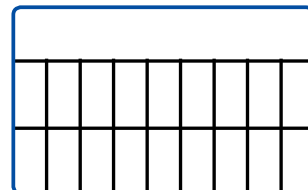

EURONET ZINC M/G rete elettrosaldata zincata prima della saldatura **Maglie Grandi**

CODICE	DISP	MAGLIA	FILO	ROTOLE	ALTEZZA	PREZZO	SCONTO
		mm	mm	mt	cm	EURO/PZ	
MAGLIA 50x25 - confezioni da 6 o 12 rotoli							
50X25H100		50x25	1,8	25	100	86,00	
50X25H125		50x25	1,8	25	125	107,50	
50X25H150		50x25	1,8	25	150	129,00	
50X25H175		50x25	1,8	25	175	150,50	
50X25H200		50x25	1,8	25	200	172,00	
MAGLIA 50x50 - confezioni da 6 o 12 rotoli							
50X50H100		50x50	1,8	25	100	58,00	
50X50H125		50x50	1,8	25	125	72,50	
50X50H150		50x50	1,8	25	150	87,00	
50X50H175		50x50	1,8	25	175	101,50	
50X50H200		50x50	1,8	25	200	116,00	
MAGLIA 75x50 TIPO "PESANTE" - confezioni da 6 rotoli							
50x75PESH100		75x50	1,8	25	100	46,00	
50x75PESH125		75x50	1,8	25	125	57,50	
50x75PESH150		75x50	1,8	25	150	69,00	
50x75PESH175		75x50	1,8	25	175	80,50	
50x75PESH200		75x50	1,8	25	200	92,00	
MAGLIA 75x50 TIPO "STANDARD" - confezioni da 16 rotoli							
50x75H100		75x50	1,7	25	100	42,00	
50x75H125		75x50	1,7	25	125	52,50	
50x75H150		75x50	1,7	25	150	63,00	
50x75H175		75x50	1,7	25	175	73,50	
50x75H200		75x50	1,7	25	200	84,00	

MAGLIA 75x50 "CERTIFICATA" - confezioni da 6 o 12 rotoli

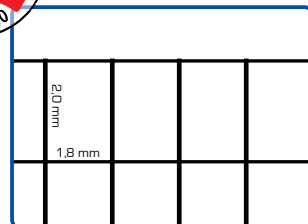
CODICE	DISP	MAGLIA	FILO	ROTOLE	ALTEZZA	PREZZO	SCONTO
		mm	mm	mt	cm	EURO/PZ	
50x75CERTH100		75x50	1,8/2,0	25	100	52,00	
50x75CERTH125		75x50	1,8/2,0	25	125	65,00	
50x75CERTH150		75x50	1,8/2,0	25	150	78,00	
50x75CERTH175		75x50	1,8/2,0	25	175	91,00	
50x75CERTH200		75x50	1,8/2,0	25	200	104,00	
Certificato di prova n° 262425 rilasciato Istituto Giordano							

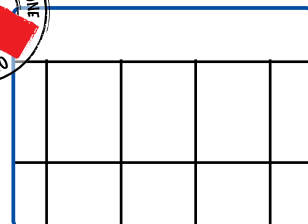

MAGLIA 75x65 "PROMO" - confezioni da 16 rotoli

CODICE	DISP	MAGLIA	FILO	ROTOLE	ALTEZZA	PREZZO	SCONTO
		mm	mm	mt	cm	EURO/PZ	
75x65PROMOH100		75x65	1,7	25	100	*	
75x65PROMOH125		75x65	1,7	25	125	*	
75x65PROMOH150		75x65	1,7	25	150	*	
75x65PROMOH175		75x65	1,7	25	175	*	
75x65PROMOH200		75x65	1,7	25	200	*	
						ordine minimo 400 rotoli	

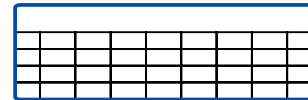
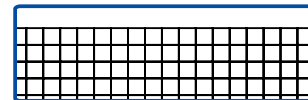

RETE ELETTROSALDATA zincata A CALDO dopo della saldatura - confezioni da 6 rotoli

CODICE	DISP	MAGLIA	FILO	ROTOLO	ALTEZZA	PREZZO	SCONTO
		mm	mm	mt	cm	EURO/PZ	
MAGLIA 6X6 - confezioni da 6 rotoli							
6x6H50		6x6	0,65	25	50	60,00	
6x6H60		6x6	0,65	25	60	72,00	
6x6H80		6x6	0,65	25	80	96,00	
6x6H100		6x6	0,65	25	100	120,00	
MAGLIA 12X25 - confezioni da 6 rotoli							
12x25F0.65		12x25	0,65	50	100	80,00	
MAGLIA 12X12 - confezioni da 6 rotoli							
12x12ZDH100F0.65		12x12	0,65	50	100	130,00	
12x12ZDH50F0.90		12x12	0,90	25	50	44,00	
12x12ZDH60F0.90		12x12	0,90	25	60	52,80	
12x12ZDH80F0.90		12x12	0,90	25	80	70,40	
12x12ZDH100F0.90		12x12	0,90	25	100	88,00	

**EURONET ZINC M/P** rete elettrosaldata zincata prima della saldatura **Maglie Piccole**

CODICE	DISP	MAGLIA	FILO	ROTOLO	ALTEZZA	PREZZO	SCONTO
		mm	mm	mt	cm	EURO/PZ	
MAGLIA 12X12 - confezioni da 6 o 12 rotoli							
12x12H50		12x12	1,40	25	50	78,00	
12x12H60		12x12	1,40	25	60	93,60	
12x12H80		12x12	1,40	25	80	125,00	
12x12H100		12x12	1,40	25	100	156,00	
MAGLIA 19X19 - confezioni da 6 o 12 rotoli							
19x19H50		19x19	1,40	25	50	52,00	
19x19H60		19x19	1,40	25	60	62,50	
19x19H80		19x19	1,40	25	80	83,50	
19x19H100		19x19	1,40	25	100	104,00	
MAGLIA 12X25 - confezioni da 6 o 12 rotoli							
12x25H50		12x25	1,40	25	50	58,50	
12x25H60		12x25	1,40	25	60	70,50	
12x25H80		12x25	1,40	25	80	94,00	
12x25H100		12x25	1,40	25	100	117,00	
* su richiesta altezze 125 - 150 - 200 cm							
MAGLIA 25X25 - confezioni da 6 o 12 rotoli							
25x25F2,05H80		25 x 25	2,05		80	125,00	
25x25F2,05H100		25 x 25	2,05		100	156,00	
25x25F2,05H125		25 x 25	2,05		125	195,00	
25x25F2,05H150		25 x 25	2,05		150	234,00	
25x25F2,05H200		25 x 25	2,05		200	312,00	

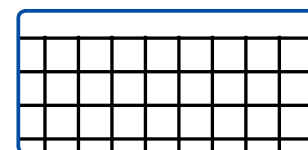
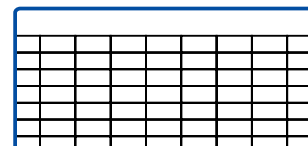
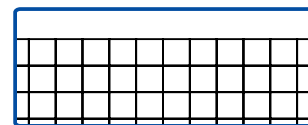
**RETE ELETTROSALDATA ZINCATA e PLASTIFICATA** - confezione 6 o 12 rotoli

12x12PH50		12x12	0,9/1,3	25	50	45,00	
12x12PH60		12x12	0,9/1,3	25	60	54,00	
12x12PH80		12x12	0,9/1,3	25	80	72,00	
12x12PH100		12x12	0,9/1,3	25	100	90,00	
12x12PH120		12x12	0,9/1,3	25	125	112,50	
12x12PH150		12x12	0,9/1,3	25	150	135,00	

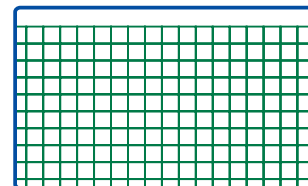
**RETE ORNAMENTALE PLASTIFICATA** - confezione 6 rotoli

ROH45				25	45	50,00	
ROH65				25	65	70,00	
ROH90				25	90	90,00	
ROH120				25	120	140,00	

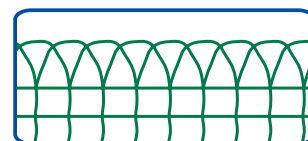

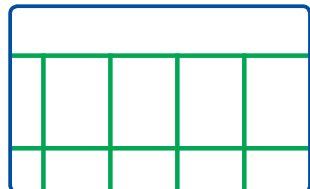
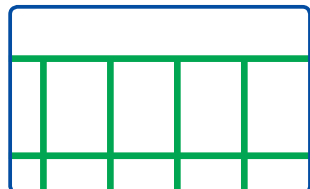
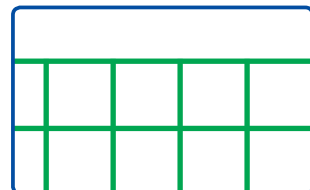
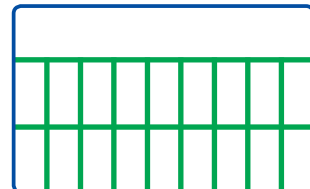

EURONET PLAST M/G rete elettrosaldata zincata prima della saldatura e plastificata **Maglie Grandi**

CODICE	DISP	MAGLIA	FILO	ROTOLO	ALTEZZA	PREZZO	SCONTO
		mm	mm	mt	cm	EURO/PZ	
MAGLIA 50x25 - confezioni da 6 o 12 rotoli							
50X25PH100		50x25	1,8/2,5	25	100	156,00	
50X25PH125		50x25	1,8/2,5	25	125	195,00	
50X25PH150		50x25	1,8/2,5	25	150	234,00	
50X25PH180		50x25	1,8/2,5	25	175	273,00	
50X25PH200		50x25	1,8/2,5	25	200	312,00	
MAGLIA 50x50 - confezioni da 6 o 12 rotoli							
50X50PH100		50x50	1,8/2,5	25	100	104,00	
50X50PH125		50x50	1,8/2,5	25	125	130,00	
50X50PH150		50x50	1,8/2,5	25	150	156,00	
50X50PH180		50x50	1,8/2,5	25	175	182,00	
50X50PH200		50x50	1,8/2,5	25	200	208,00	
MAGLIA 75x50 TIPO "PESANTE" - confezioni da 6 o 12 rotoli							
50x75H100PES		75x50	1,8/2,5	25	100	73,00	
50x75H125PES		75x50	1,8/2,5	25	125	91,00	
50x75H150PES		75x50	1,8/2,5	25	150	109,50	
50x75H175PES		75x50	1,8/2,5	25	175	127,50	
50x75H200PES		75x50	1,8/2,5	25	200	146,00	
MAGLIA 75x50 TIPO "STANDARD" - confezioni da 6 o 16 rotoli							
50x75PH100		75x50	1,7/2,3	25	100	62,00	
50x75PH125		75x50	1,7/2,3	25	125	77,50	
50x75PH150		75x50	1,7/2,3	25	150	93,00	
50x75PH175		75x50	1,7/2,3	25	175	108,50	
50x75PH200		75x50	1,7/2,3	25	200	124,00	

MAGLIA 100x50 TIPO "GARDEN PESANTE 2 FILI" - confezioni da 6 o 12 rotoli

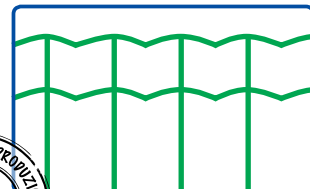
CODICE	DISP	MAGLIA	FILO	ROTOLO	ALTEZZA	PREZZO	SCONTO
		mm	mm	mt	cm	EURO/PZ	
100x50P2FILH100		100x50	1,8/2,5	25	100	70,00	
100x50P2FILH125		100x50	1,8/2,5	25	125	87,50	
100x50P2FILH150		100x50	1,8/2,5	25	150	105,00	
100x50P2FILH175		100x50	1,8/2,5	25	175	122,50	
100x50P2FILH200		100x50	1,8/2,5	25	200	140,00	

MAGLIA 100x50 TIPO "STANDARD" - confezioni da 16 rotoli

CODICE	DISP	MAGLIA	FILO	ROTOLO	ALTEZZA	PREZZO	SCONTO
		mm	mm	mt	cm	EURO/PZ	
100x50POH100		100x50	1,7/2,3	25	100	58,00	
100x50POH125		100x50	1,7/2,3	25	125	72,50	
100x50POH150		100x50	1,7/2,3	25	150	87,00	
100x50POH175		100x50	1,7/2,3	25	175	101,00	
100x50POH200		100x50	1,7/2,3	25	200	116,00	

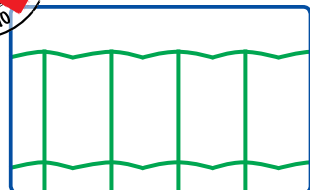

RETE AGROPASTORALE ANNODATA

CODICE	DISP	MAGLIA	FILO	ROTOLO	ALTEZZA	PREZZO	SCONTO
		mm	mm	mt	cm	EURO/rotolo	

TIPO "STANDARD" - confezioni da 20 rotoli

RPH100MT50		8x15	1,8/2,2	50	100	48,00	
RPH120MT50		9x15	1,8/2,2	50	120	58,00	
RPH140MT50		11x15	1,8/2,2	50	140	70,00	
RPH100MT100		8x15	1,8/2,2	100	100	96,00	
RPH120MT100		9x15	1,8/2,2	100	120	116,00	
RPH140MT100		11x15	1,8/2,2	100	140	140,00	
RPH100MT1008X30		8X30	1,8/2,2	100	100	72,00	

TIPO "PESANTE" - confezioni da 12 rotoli

RPH100MT50PESANTE		8x15	2,5/3,0	50	100	90,00	
RPH120MT50PESANTE		9x15	2,5/3,0	50	120	100,00	
RPH140MT50PESANTE		11x15	2,5/3,0	50	140	115,00	
RPH100MT100PESANTE		8x15	2,5/3,0	100	100	180,00	
RPH120MT100PESANTE		9x15	2,5/3,0	100	120	200,00	
RPH140MT100PESANTE		11x15	2,5/3,0	100	140	230,00	

TIPO "EXTRA PESANTE" - confezioni da 9 rotoli

RPH100MT50EXTRPES		8x15	3,5/4,0	50	100	135,00	
RPH120MT50EXTRPES		9x15	3,5/4,0	50	120	155,00	
RPH140MT50EXTRPES		11x15	3,5/4,0	50	140	180,00	

PROMO - confezioni da 25 rotoli

RPH100MT50PROMO		8x15	1,7/2,0	50	100	*	
RPH120MT50PROMO		9x15	1,7/2,0	50	120	*	
RPH100MT50PROMOPES		8x15	2,2/3,0	50	100	*	
RPH120MT50PROMOPES		9x15	2,2/3,0	50	120	*	
ordine minimo 400 rotoli							

RETE ZINCATA TRIPLA TORSIONE - confezione 6 e 12 rotoli

CODICE	DISP	MAGLIA	FILO	ROTOLO	ALTEZZA	PREZZO	SCONTO
		mm	mm	mt	cm	EURO/rotolo	
RTT16/2H100		16/2	0,7	25	100	40,00	
RTT16/2H120		16/2	0,7	25	120	48,00	
RTT16/2H150		16/2	0,7	25	150	60,00	
RTT16/2H200		16/2	0,7	25	200	80,00	
RTT25/3H100		25/3	0,8	25	100	30,00	
RTT25/3H120		25/3	0,8	25	120	37,50	
RTT25/3H150		25/3	0,8	25	150	45,00	
RTT25/3H200		25/3	0,8	25	200	60,00	
RTT51/6H100		51/6	1,1	25	100	27,00	
RTT51/6H120		51/6	1,1	25	120	33,75	
RTT51/6H150		51/6	1,1	25	150	40,50	
RTT51/6H200		51/6	1,1	25	200	54,00	

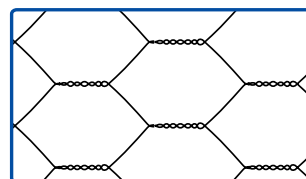
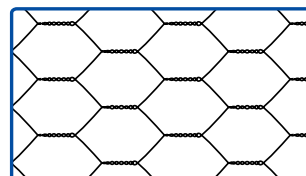
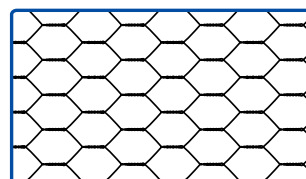
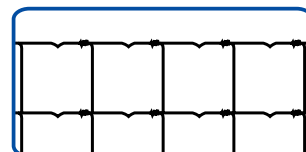
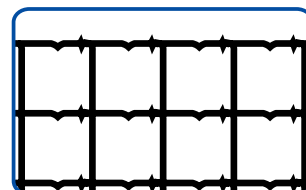
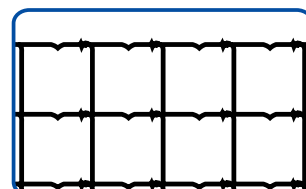
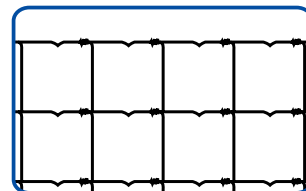

Listino prezzi OTTOBRE 2014



RETE GRIGLIA ZINCATA - confezione 12 rotoli

CODICE	DISP	MAGLIA	FILO	ROTOLO	ALTEZZA	PREZZO	SCONTO
		mm	mm	mt	cm	EURO/rotolo	
MAGLIA 50x50 TIPO "STANDARD"							
GZF13H100		50x50	1,8	25	100	52,00	
GZF13H125		50x50	1,8	25	125	65,00	
GZF13H150		50x50	1,8	25	150	78,00	
GZF13H175		50x50	1,8	25	175	91,00	
GZF13H200		50x50	1,8	25	200	104,00	
MAGLIA 50x50 TIPO "PESANTE"							
GZF14H100		50x50	2,2	25	100	78,00	
GZF14H125		50x50	2,2	25	125	97,50	
GZF14H150		50x50	2,2	25	150	117,00	
GZF14H175		50x50	2,2	25	175	136,50	
GZF14H200		50x50	2,2	25	200	156,00	
GZF14H225		50x50	2,2	25	225	200,00	
GZF14H250		50x50	2,2	25	250	220,00	
GZF14H300		50x50	2,2	25	300	270,00	

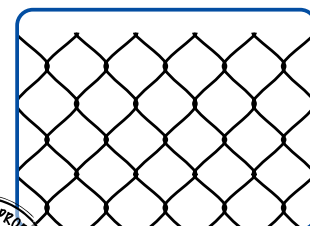
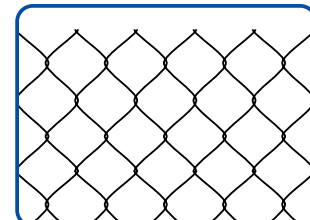

RETE GRIGLIA ZINCATA e PLASTIFICATA - confezione 12 rotoli

CODICE	DISP	MAGLIA	FILO	ROTOLO	ALTEZZA	PREZZO	SCONTO
		mm	mm	mt	cm	EURO/rotolo	
MAGLIA 50x50 TIPO "STANDARD"							
GPF13H100		50x50	1,8/2,5	25	100	65,00	
GPF13H125		50x50	1,8/2,5	25	125	81,50	
GPF13H150		50x50	1,8/2,5	25	150	97,50	
GPF13H175		50x50	1,8/2,5	25	175	114,00	
GPF13H200		50x50	1,8/2,5	25	200	130,00	
GPF13H250		50x50	1,8/2,5	25	250	190,00	
GPF13H300		50x50	1,8/2,5	25	300	230,00	
MAGLIA 50x50 TIPO "PESANTE"							
GPF14H100		50x50	2,2/3,0	25	100	100,00	
GPF14H125		50x50	2,2/3,0	25	125	125,00	
GPF14H150		50x50	2,2/3,0	25	150	150,00	
GPF14H175		50x50	2,2/3,0	25	175	175,00	
GPF14H200		50x50	2,2/3,0	25	200	200,00	
GPF14H225		50x50	2,2/3,0	25	225	270,00	
GPF14H250		50x50	2,2/3,0	25	250	300,00	
GPF14H300		50x50	2,2/3,0	25	300	360,00	
MAGLIA 50x50 TIPO "EXTRA PESANTE SPORT" rotolo grande confezione su richiesta							
GPF17H200		50x50	3,2/4,4	15	200	290,00	
GPF17H250		50x50	3,2/4,4	12,5	250	300,00	
GPF17H300		50x50	3,2/4,4	12,5	300	360,00	

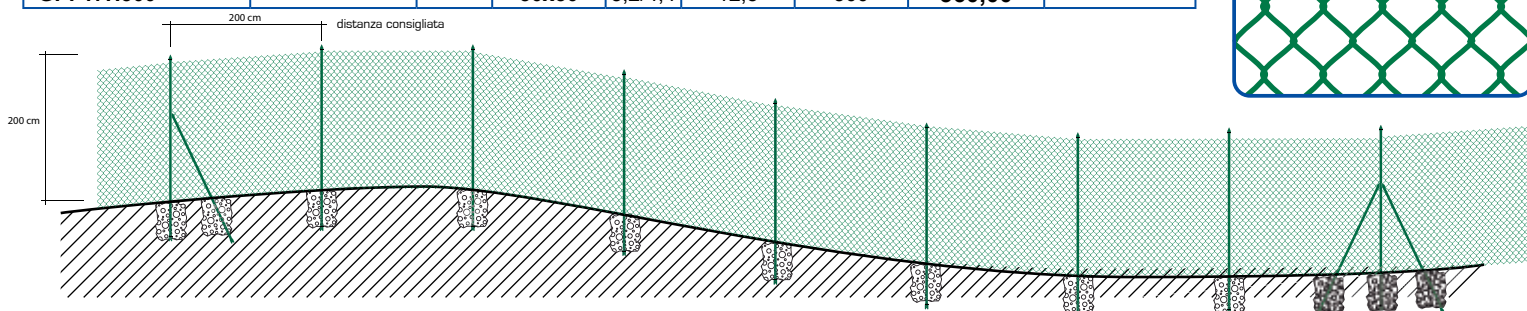
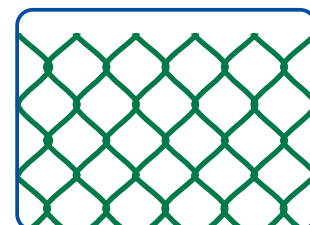
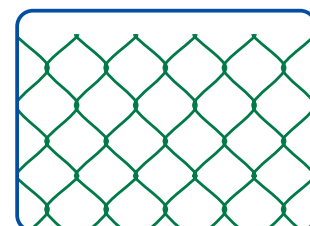
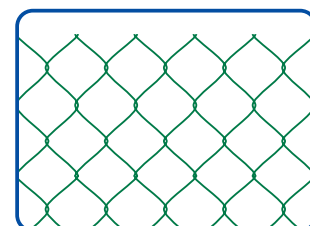

PALO a U "PROMOPAL" per RECINZIONI 35X40X35 ZINCATO - confezione da 100 pz regettati

CODICE	altezze	spessore	PREZZO	SCONTO
PROMOPAL40x30H125	125	1,50	3,50	
PROMOPAL40x30H150	150	1,50	4,20	
PROMOPAL40x30H175	175	1,50	4,90	
PROMOPAL40x30H200	200	1,50	5,60	
PROMOPAL40x30H225	225	1,50	6,30	
PROMOPAL40x30H250	250	1,50	7,00	

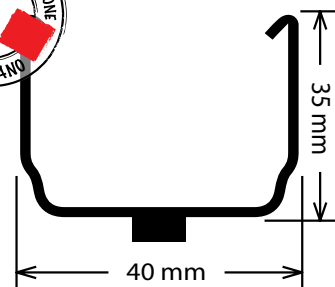
**PALO TONDO PER RECINZIONE diam. 48 mm ZINCATO** - confezione da 100 pz regettati

CODICE	altezze	spessore	PREZZO	SCONTO
PZTØ48H125	125	1,00	5,00	
PZTØ48H150	150	1,00	6,00	
PZTØ48H175	175	1,00	7,00	
PZTØ48H200	200	1,00	8,00	
PZTØ48H225	225	1,00	9,00	
PZTØ48H250	250	1,00	10,00	
PZTØ48H300	300	1,00	12,00	
PZTØ48H600	600	1,00	24,00	

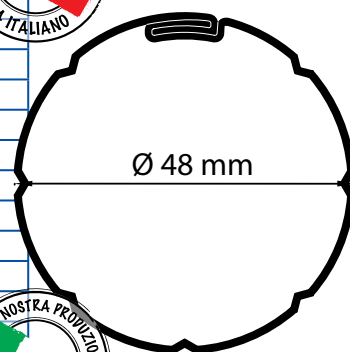
**PALO a U tipo "AUTOSTRADA" 30x50x30 mm zincato per recinzione** - confezione da 100 pz regettati

CODICE	altezze	spessore	PREZZO	SCONTO
PZ30x50x2,5mmH125	125	2,50	6,25	
PZ30x50x2,5mmH150	150	2,50	7,50	
PZ30x50x2,5mmH175	175	2,50	8,75	
PZ30x50x2,5mmH200	200	2,50	10,00	
PZ30x50x2,5mmH225	225	2,50	11,25	
PZ30x50x2,5mmH250	250	2,50	12,00	

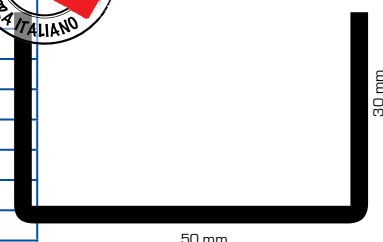

PALETTI A "T" PLASTIFICATI PER RECINZIONE - confezione da 10 a 100 paletti regettati

CODICE	DISP	SPESSORE	ALTEZZA	PREZZO	SCONTO
		mm	cm	EURO/palo	
PPH12530x30x3,0		30x30x3,0	125	4,00	
PPH15030x30x3,0		30x30x3,0	150	4,80	
PPH17530x30x3,0		30x30x3,0	175	5,60	
PPH20030x30x3,0		30x30x3,0	200	6,40	
PPH22530x30x3,0		30x30x3,0	225	7,20	
PPH25030x30x3,0		30x30x3,0	250	8,00	
PP35H20035x35x3,5		35x35x3,5	200	8,40	
PP35H22535x35x3,5		35x35x3,5	225	9,40	
PP35H25035x35x3,5		35x35x3,5	250	10,50	

**PALETTI A "T" ZINCATI PER RECINZIONE** - confezione da 10 a 100 paletti regettati

CODICE	DISP	SPESSORE	ALTEZZA	PREZZO	SCONTO
		mm	cm	EURO/palo	
PZH12530x30x3,0		30x30x3,0	125	4,60	
PZH15030x30x3,0		30x30x3,0	150	5,50	
PZH17530x30x3,0		30x30x3,0	175	6,40	
PZH20030x30x3,0		30x30x3,0	200	7,40	
PZH22530x30x3,0		30x30x3,0	225	8,30	
PZH25030x30x3,0		30x30x3,0	250	9,30	
PZ35H20035x35x3,5		35x35x3,5	200	10,00	
PZ35H22535x35x3,5		35x35x3,5	225	11,00	
PZ35H25035x35x3,5		35x35x3,5	250	12,50	

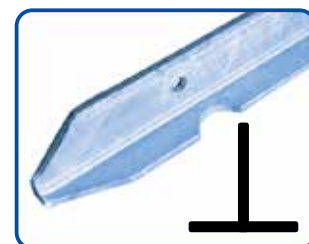
**SAETTE PLASTIFICATE ad "L"** - confezione da 10 pz

CODICE	DISP	SPESSORE	ALTEZZA	PREZZO	SCONTO
		mm	cm	EURO/pezzo	
SPLH12025x25x3		25x25x3	120	4,00	
SPLH15025x25x3		25x25x3	150	4,80	
SPLH20025x25x3		25x25x3	200	6,40	

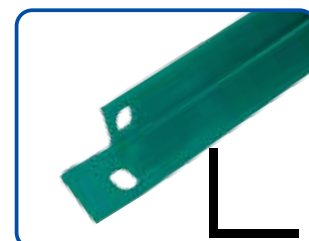
**SAETTE ZINCATI ad "L"** - confezione da 10 pz

CODICE	DISP	SPESSORE	ALTEZZA	PREZZO	SCONTO
			cm	EURO/pezzo	
SZLH12025x25x3		25x25x3	120	4,60	
SZLH15025x25x3		25x25x3	150	5,50	
SZLH20025x25x3		25x25x3	200	7,40	

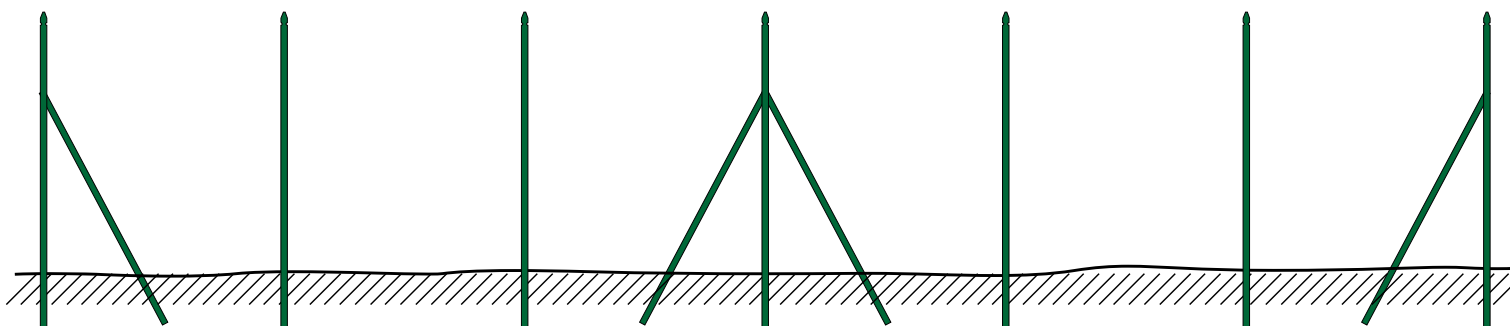
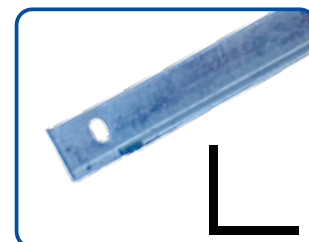

FILO ZINCATO PER TENSIONE - confezione da 50 kg in balle da 500 kg

CODICE	DISP	N.	DIAMETRO	PREZZO	SCONTO
			mm	EURO/Kg	
FZ5		5	1,0	2,50	
FZ6		6	1,1	2,40	
FZ8		8	1,3	2,30	
FZ10		10	1,5	2,25	
FZ12		12	1,8	2,20	
FZ13		13	2,0	2,15	
FZ14		14	2,2	2,00	
FZ16		16	2,7	1,95	
FZ17		17	3,0	1,95	
FZ18		18	3,5	1,95	
FZ20		20	4,5	1,95	
FZ22		22	5,5	2,05	
FZ24		24	6,5	2,20	

**FILO PLASTIFICATO PER TENSIONE** - confezione da 50 kg in balle da 500 kg

CODICE	DISP	N.	DIAMETRO	PREZZO	SCONTO
			mm	EURO/Kg	
FP13		13	1,5/2,0	3,00	
FP16		15	1,8/2,5	2,80	
FP17		17	2,2/3,0	2,70	
FP19		20	3,2/4,4	2,60	

**FILO SPINATO ZINCATO** - confezione da 16 rotoli o pedana da 64 rotoli

CODICE	TIPO	Diametro	lunghezza	PREZZO	SCONTO
		mm	mt	EURO/rotolo	
FS12MT100	leggero	1,7	100	16,00	
FS12MT200	leggero	1,7	200	32,00	
FS13MT100	standard	1,8	100	20,00	
FS13MT200	standard	1,8	200	40,00	
FS14	pesante	14 (mm. 2,20)	200	48,60	
FS16	extra pesante	16 (mm. 2,70)	200	80,00	

**FILO SPINATO ZINCATO e PLASTIFICATO** - confezione da 16 rotoli o pedana da 64 rotoli

CODICE	TIPO	Diametro	lunghezza	PREZZO	SCONTO
			mt	EURO/rotolo	
FSP13MT100	standard	13 (mm. 1,8/2,5)	100	26,00	
FSP13MT200	standard	13 (mm. 1,8/2,5)	200	52,00	
FSP14	pesante	14 (mm. 2,2/3,0)	200	3,50	



ROTOLE DI FILO PLASTIFICATO

CODICE	Tipo	Confezioni	N.	DIAMETRO mm	Lunghezza mt	PREZZO EURO/rotolo	SCONTO
FPXLEG2,0MT10	legature	30 rotoli	13	1,4/2,0	10	2,50	
FPXLEG1,3MT25	legature	30 rotoli	8	0,9/1,3	25	2,80	
FPXLEG0,9MT50	legature	30 rotoli	4	0,6/0,9	50	3,00	
FPXLEG1,8MT100	legature	30 rotoli	12	1,2/1,8	100	5,00	
FPXTENS2,8MT100	tensione	10 rotoli	16	2,0/2,8	100	10,00	
FPXTENS3,1MT100	tensione	10 rotoli	17	2,2/3,1	100	12,30	

ROTOLE DI FILO ZINCATO - confezione da 30/10 rotoli

CODICE	Tipo	Confezioni	N.	DIAMETRO mm	Lunghezza mt	PREZZO EURO/pz	SCONTO
FZXLEG2,0MT10	legature	30 rotoli	13	2,0	10	2,50	
FZXLEG1,3MT25	legature	30 rotoli	7	1,2	25	2,80	
FZXLEG0,9MT50	legature	30 rotoli	2	0,7	50	3,00	
FZXLEG1,5MT100	legature	30 rotoli	10	1,5	100	6,00	
FZXLEG1,8MT100	legature	10 rotoli	12	1,8	100	9,00	
FZXTENS2,2MT100	tensione	10 rotoli	14	2,2	100	10,00	
FZXTENS2,7MT100	tensione	10 rotoli	16	2,7	100	12,00	

TENDITORI ZINCATI - confezione da 100 pz

CODICE	DISP	TIPO	PREZZO EURO/pz	SCONTO
TEND.ZINC COLL		zincato	0,70	

TENDITORI ZINCATI E PLASTIFICATI - confezione da 100 pz

CODICE	DISP	TIPO	PREZZO EURO/pz	SCONTO
TEND.VERDI COLL		plastificato	0,80	

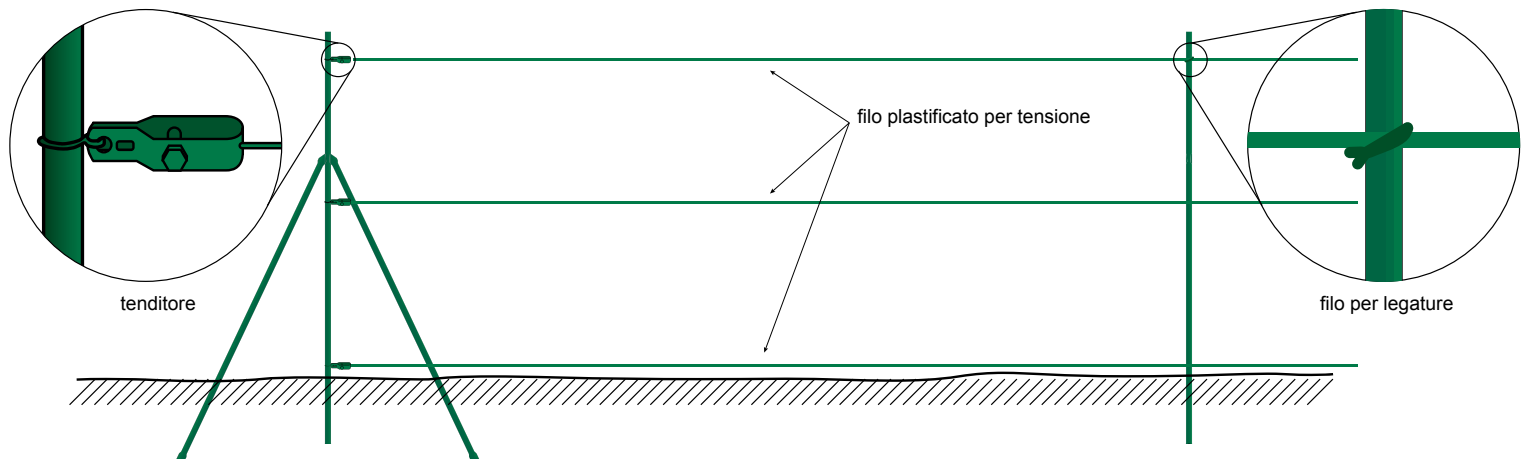

SISTEMI DI RECINZIONE

**Recinzione Rete Griglia
si adatta al dislivello del terreno**

Rete Griglia

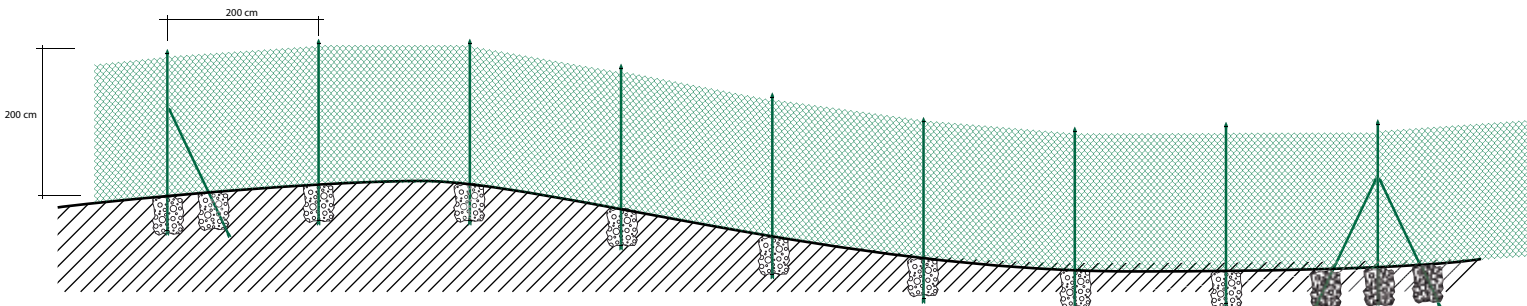
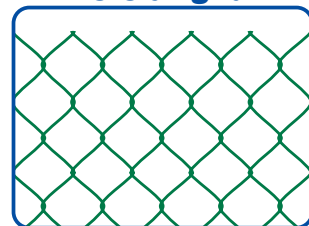

**Recinzione Rete Elettrosaldata 50x75
economica e facile da montare...**

Rete Elettrosaldata

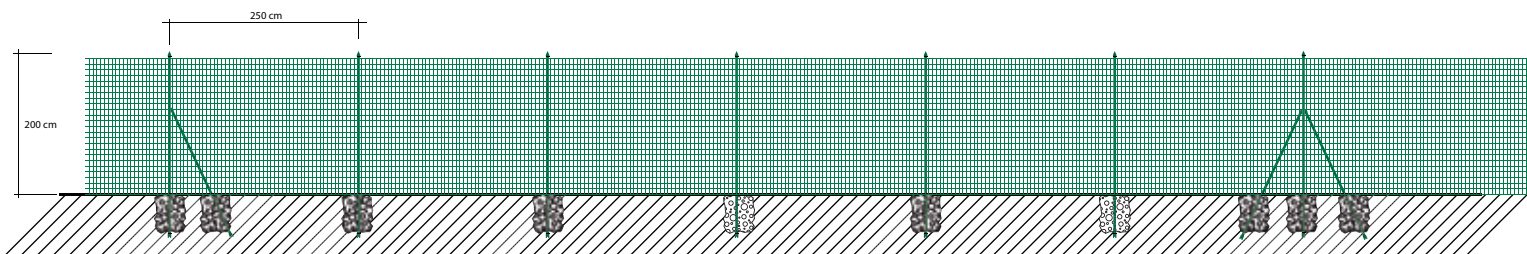
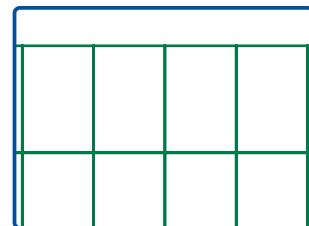

**Recinzione con Pannello "Villa"
bella, economica e facile da montare...**

Pannello "Villa"

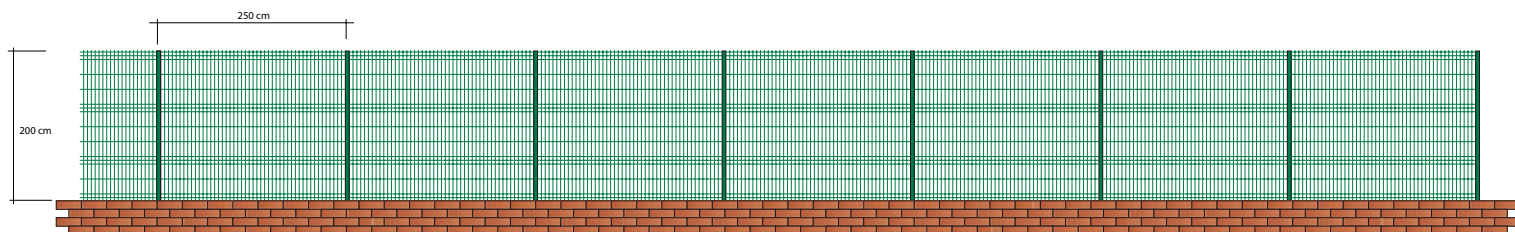
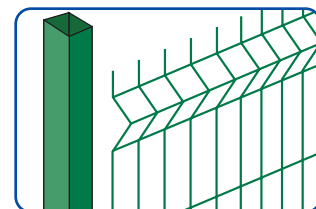

PANNELLO PER MASSETTI 2x1 - confezione da 700 pz su pallet

Codice	filo mm	maglia mm	PREZZO EURO/PZ	SCONTO
METALPAN55x55F1,40	1,40	55x55	2,20	
METALPAN75x75F1,70	1,70	75x75	2,30	
METALPAN50X50F3,00	3,00	50x50	13,00	
METALPAN75X75F3,00	3,00	75x75	11,00	

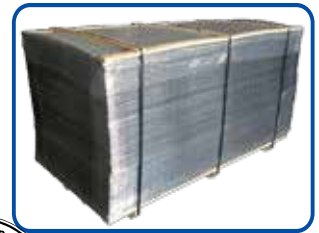
**FILO COTTO BIANCO A MATASSINE da gr. 330** - confezione da 25 kg in cartone su pedana da 1500 kg

Codice	n°	Fili	mm	PREZZO EURO/KG	SCONTO
FM4X2	4	2	0,9	2,30	
FM5X2	5	2	1,0	2,20	
FM4X3	4	3	0,9	2,35	
FM5x3	5	3	1,0	2,35	
FM8x1	8	1	1,3	2,35	

**FILO COTTO NERO** - confezione da +/- 50 kg in balle da +/- 500 kg

Codice	n°	mm	PREZZO EURO/KG	SCONTO
FN4	4	0,90	2,20	
FN5	5	1,00	2,10	
FN6	6	1,10	2,04	
FN8	8	1,30	2,04	
FN10	10	1,50	2,00	
FN12	12	1,80	1,90	
FN13	13	2,00	1,87	
FN14	14	2,20	1,83	
FN16	16	2,70	1,78	
FN17	17	3,00	1,78	
FN18	18	3,50	1,78	
FN20	20	4,50	1,78	
FN21	21	5,00	1,90	

**CHIODI TESTA PIANA** - confezione da 5 kg su pedana da 1200 kg

Codice	n°	Misura	PREZZO EURO/KG	SCONTO
TP3	3	13x30	2,10	
TP4	4	14x40	1,95	
TP5	5	15x50	1,80	
TP6	6	16x60	1,75	
TP7	7	17x70	1,75	
TP17X55	7,5	17X55	1,75	
TP8	8	18x80	1,75	
TP9	9	19x90	1,75	
TP10	10	20x100	1,75	
TP12	12	21x120	1,75	
TP14	14	22x140	1,75	
TP16	16	23x160	1,85	
TP18	18	24x180	2,00	
TP20	20	24x200	2,00	



CHIODI IN ACCIAIO NERI testa bombata - confezione da 2,5 kg x 4 su pedana da 1000 kg

Codice	mm	Lunghezza	PREZZO EURO/KG	SCONTO
TPA43,5X40	3,5	40	2,80	
TPA53,5X50	3,5	50	2,80	
TPA63,5X60	3,5	60	2,80	

**CHIODI IN ACCIAIO ZINCATI testa piana** - confezione da 2,5 kg x 4 su pedana da 1000 kg

Codice	mm	Lunghezza	PREZZO EURO/KG	SCONTO
TPAZ43,5X40	3,5	40	3,00	
TPAZ53,5X50	3,5	50	2,90	
TPAZ63,5X60	3,5	60	3,00	

**CAMBRETTE ZINcate** - confezione da 5 kg su pedana da 1200 kg

Codice	mm	Misura	PREZZO EURO/KG	SCONTO
CAM13X25	2	13x25	3,40	
CAM14X30	2,2	14x30	3,30	
CAM16X30	2,7	16x30	3,20	
CAM17X35	3	17x35	3,00	
CAM18X40	3,5	18x40	3,00	

**CHIODI GRUPPINO** - confezione da 5 kg su pedana da 1000 kg

Codice	mm	Misura	PREZZO EURO/KG	SCONTO
TPGR15X25	1,5	25	3,00	
TPGR1,5X30	1,5	30	3,00	
TPGR1,8X40	1,8	40	3,00	

**CHIODI TESTA PIANA LARGA** - confezione da 5 kg su pedana da 1000 kg

Codice	mm	Lunghezza	PREZZO EURO/KG	SCONTO
TPL1,6X14	1,6	14	3,00	
TPL1,8X20	1,8	20	3,00	
TPL2,2X30	2,2	30	3,00	



DISTANZIATORI PER ARMATURA - confezione da 100 pz in busta su pedana

				PREZZO	SCONTO
Codice	L/cm.			EURO/PZ	
DIS10	10			13,69	
DIS15	15			15,55	
DIS20	20			18,04	
DIS25	25			20,29	
DIS30	30			22,00	
DIS35	35			24,96	
DIS40	40			28,15	
DIS45	45			28,65	
DIS50	50			31,92	
DIS55	55			33,27	
DIS60	60			36,94	
DIS65	65			38,73	
DIS70	70			41,18	
DIS75	75			43,04	
DIS80	80			46,62	
DIS85	85			48,41	
DIS90	90			51,81	
DIS95	95			53,13	
DIS100	100			58,44	
DIS120	120			66,41	

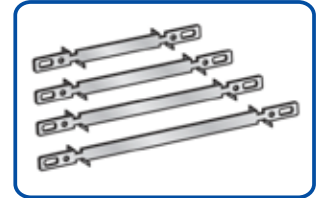
**STAFFE AD ELICA** - confezione da 100 pz in busta

				PREZZO	SCONTO
Codice	Montante			EURO/PZ	
STAFF.ELICA	cm 50			2,07	

**MONTANTI AD "U"** - bancali da 500 pz per tipo su richiesta

				PREZZO	SCONTO
Codice	Montante	ZINCATO		EURO/PZ	
MONT50	da 50 cm			2,00	
MONT100	da 100 cm			4,00	
MONT150	da 150 cm			5,80	
Codice	Montante			PREZZO	SCONTO
MONT-ZINC120	da 120 cm	ZINCATO		*	
MONT-MULT120	da 120 cm	MULTIFORO		*	
MONT-AC120	da 120 cm	A "C"		5,00	

**CUNEI PER MONTANTI GREZZI NERI** - bancali da 100 scatole su richiesta

				PREZZO	SCONTO
Codice	Conf. pezzi			EURO/CONF	
CUNEI grande	100			28,10	



GABBIONI a scatola senza diaframmi con coperchio* - FORTE ZINCATURA

	MAGLIA	FILO	DIMENSIONI	PESO	confezioni da 50 pz	
					PREZZO	SCONTO
	cm	mm	m	Kg/cad	euro /cad	
GABFZ8X10F271511	8X10	2.70	1,5x1x1	13,00	49,00	
GABZ8X10F271511	8X10	2.70	2x1x0,5	13,00	48,00	
GABZ8X10F27211	8X10	2.70	2x1x1	15,30	52,00	
GABZ8X10F27311	8X10	2.70	3x1x1	21,30	74,00	
GABZ8X10F3211	8x10	3.00	2x1x1	19,20	65,00	

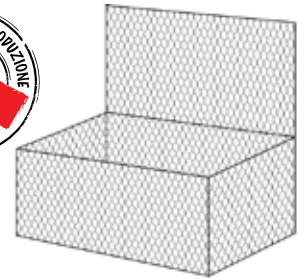
**GABBIONI a scatola senza diaframmi con coperchio* - ZINCO ALLUMINIO**

	MAGLIA	FILO	DIMENSIONI	PESO	confezioni da 50 pz	
					PREZZO	SCONTO
	cm	mm	m	Kg/cad	euro /cad	
GABFZA810F271511	8X10	2,70	1,5x1x1	12,40	51,00	
GABFZA810F27211	8X10	2,70	2x1x1	15,30	54,00	
GABFZA810F27311	8X10	2,70	3x1x1	20,32	76,00	



CON MARCATURA "C"

**GABBIONI a scatola senza diaframmi con coperchio* - ZINCO ALLUMINIO + PVC**

	MAGLIA	FILO	DIMENSIONI	PESO	confezioni da 50 pz	
					PREZZO	SCONTO
	cm	mm	m	Kg/cad	euro /cad	
GABFZAP810F27371511	8X10	2,7/3,7	1,5x1x1	15,60	68,00	
GABFZAP810F2737211	8X10	2,7/3,7	2x1x1	19,30	80,00	
GABFZAP810F2737311	8X10	2,7/3,7	3x1x1	25,60	110,00	

**RETE A DOPPIA TORSIONE - FORTE ZINCATURA - confezioni da 1 rotolo**

	MAGLIA	FILO	DIMENSIONI	PESO	confezioni da 1 rotolo	
					PREZZO	SCONTO
	cm	mm	m	Kg/mq	euro/rotolo	
RFZ81027/1X50	8x10	2.70	1x50	1,40	242,50	
RFZ81027/1,5X50	8x10	2.70	1,5x50	1,40	364,00	
RFZ81027/2X50	8x10	2.70	2x50	1,40	485,00	
RFZ81027/3X50	8x10	2.70	3x50	1,40	727,50	
RFZ8103/2X50	8x10	3.00	2x50	1,70	550,00	
RFZ8103/3X50	8x10	3.00	3x50	1,70	825,00	
RFZ6827/2X50	6x8	2.70	2x50	1,75	660,00	
RFZ6827/3X50	6x8	2.70	3x50	1,75	990,00	
RETE/DT/Z/68/F22/250	6x8	2.20	2x50	1,20	458,00	
RETE/DT/Z/68/F22/350	6x8	2.20	3x50	1,20	687,00	

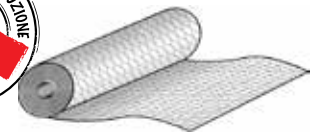

PANNELLO Mobile saldato Zincato "4 tubi STANDARD" - confezione 35 pz

Codice		dimensioni mm	PREZZO EURO/PZ	SCONTO
PANEL-RINF3200x200		3200x2000	44,00	
TARG-PERS	Targhetta personalizzata		2,00	
	Costo cliché per prima stampa		200,00	

PANNELLO Mobile saldato Zincato "2 tubi STANDARD" - confezione 35 pz

Codice		dimensioni mm	PREZZO EURO/PZ	SCONTO
PANEL-2T3300x2000	pannello	3300x2000	42,00	
TARG-PERS	Targhetta personalizzata		2,00	
	Costo cliché		200,00	

PANNELLO Mobile saldato Zincato "4 tubi" basso - confezione 35 pz

Codice		dimensioni mm	PREZZO EURO/PZ	SCONTO
*		3300x1000	40,00	
TARG-PERS	Targhetta personalizzata		2,00	
	Costo cliché per prima stampa		200,00	

MINI PANNELLO saldato Zincato "4 tubi" - confezione 35 pz

Codice		dimensioni mm	PREZZO EURO/PZ	SCONTO
MINI PAN 4 TUBI 2000x2000		2000x2000	40,00	
TARG-PERS	Targhetta personalizzata		2,00	
	Costo cliché per prima stampa		200,00	

Cancello saldato Zincato "4 tubi" - confezione 35 pz

Codice		dimensioni mm	PREZZO EURO/PZ	SCONTO
CANC 4 TUBI 1000x2000		1000x2000	38,00	
TARG-PERS	Targhetta personalizzata		2,00	
	Costo cliché per prima stampa		200,00	

BASAMENTO in Cemento "CLS" - confezione 40 pz su pallet

Codice			PREZZO EURO/PZ	SCONTO
PLINTCLS			7,00	

BASAMENTO in Plastica ARANCIO "PVC" - confezione 40 pz su pallet

ripieno di cemento			PREZZO EURO/PZ	SCONTO
PLINTPVC			12,00	

MORSETTI blocca tubi ZINCATI - confezione da 100 pz in cartone

Codice			PREZZO EURO/PZ	SCONTO
MORS ZINC	ZINCATI		4,00	
MORS AR	ARANCIO		5,00	

CERNIERE per Cancelli e Porte - confezione 10 pz

Codice			PREZZO EURO/PZ	SCONTO
CERNIERE X CANC			8,80	

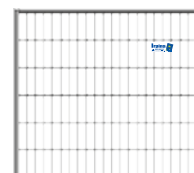
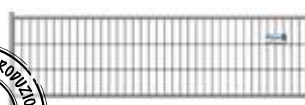
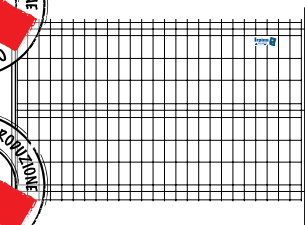
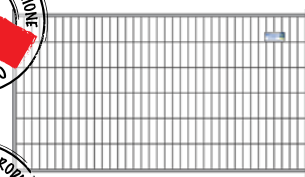

Pannello "Villa" filo su filo plastificato

RECINZIONI FISSE

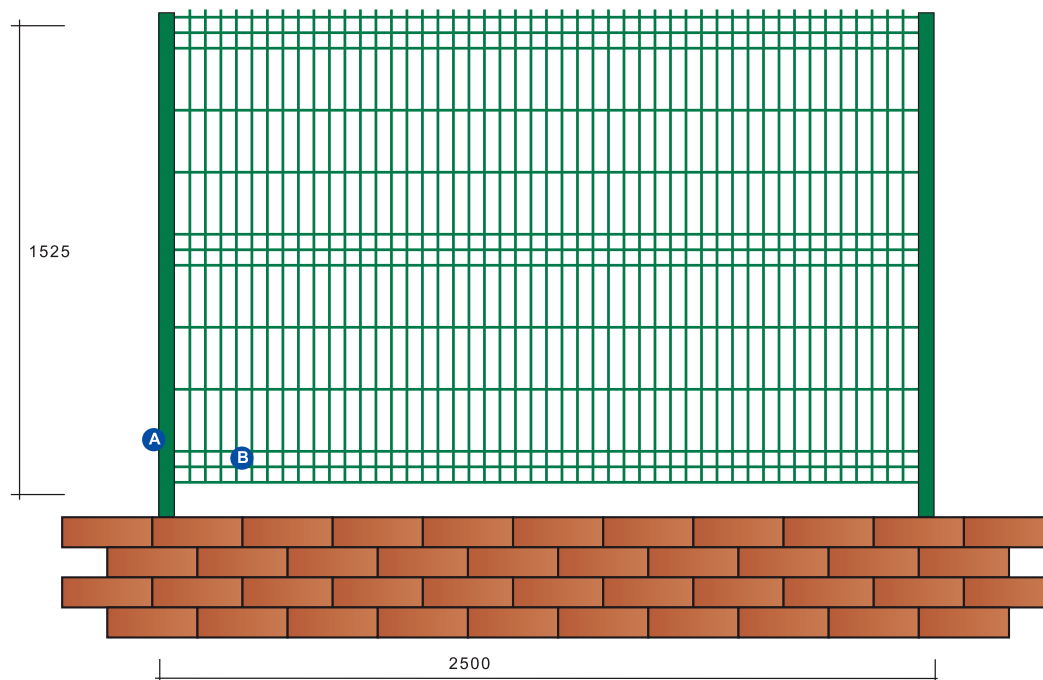

scala 1:25

- A** Palo zincato e plastificato QUADRO 60 x 60 mm
- B** Palo zincato e plastificato TONDO 48 mm
- C** Pannello elettrosaldato zincato e plastificato con pieghe di rinforzo lunghezza 2500 mm filo 5,00 mm maglia 50x200 mm - altezze varie
- D** Palo zincato e plastificato QUADRO 60 x 60 mm con piastra

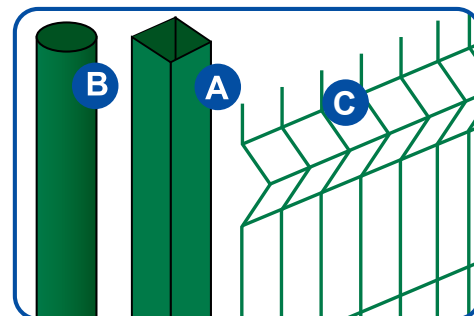

appoggiare il pannello B sul montante A

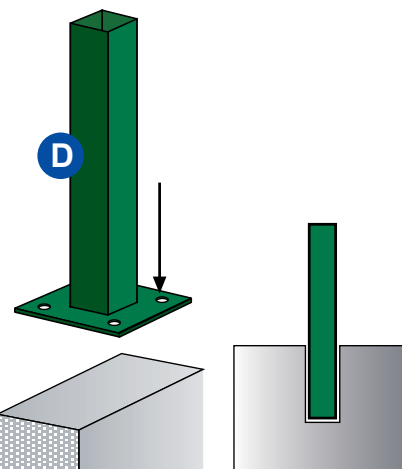
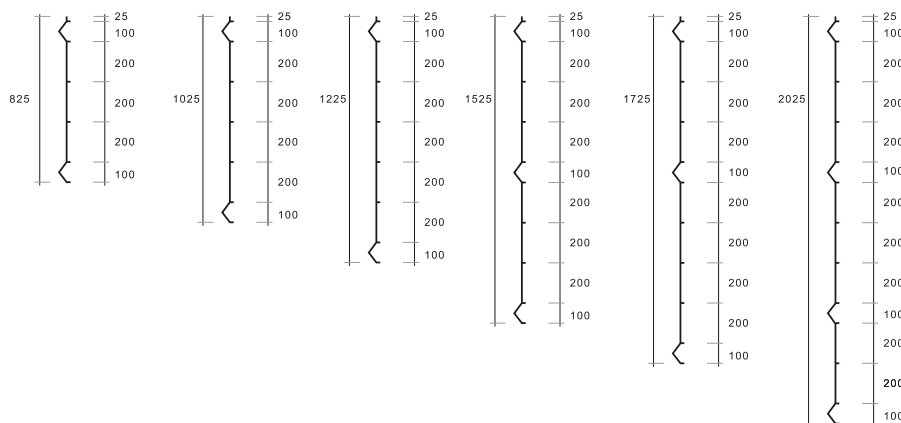

Sistemi di Fissaggio del montante.

COLORI DISPONIBILI

- Verde**
RAL6005
- Micaceo**
- Zincato**

COLORI POSSIBILI *ordine minimo 100 pz*

- | | | |
|--------------------------|-----------------------------|-----------------------|
| Giallo
RAL1018 | Bianco
RAL9003 | Blu
RAL5002 |
| Rosso
RAL3020 | Arancione
RAL2004 | Grigio |

Listino prezzi OTTOBRE 2014

RECINZIONI FISSE

PANNELLO "VILLA STANDARD" maglia 200x50 filo 5/5 interasse 2500 VERDE RAL 6005

Codice	Pannello		Palo cementato 60x60x1,50		Fissaggio	Recinzione	SCONTO
	H x L mm	Costo €/cad	Altezza mm	Costo €/cad	Costo €	completa €/mq	
	830x2500	33,50	1130	17,00	2 x 4,00	28,20	
	1030x2500	38,00	1350	20,00	2 x 4,00	25,63	
	1230x2500	46,00	1530	23,00	2 x 4,00	25,04	
	1530x2500	56,50	1830	27,50	3 x 4,00	25,10	
	1730x2500	62,70	2000	30,00	3 x 4,00	24,21	
	2030x2500	75,52	2330	35,00	4 x 4,00	24,93	

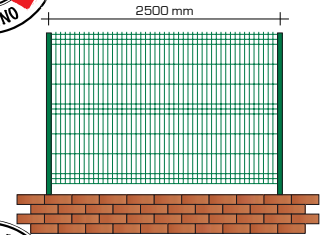

PANNELLO "VILLA CORTO" maglia 200x50 filo 5/5 interasse 2000 VERDE RAL 6005

Codice	Pannello		Palo cementato 60x60x1,50		Fissaggio	Recinzione	SCONTO
	H x L mm	Costo €/cad	Altezza mm	Costo €/cad	Costo €	completa €/mq	
	830x2000	28,20	1130	17,00	2 x 4,00	32,10	
	1030x2000	31,00	1350	20,00	2 x 4,00	28,64	
	1230x2000	37,00	1530	23,00	2 x 4,00	27,64	
	1530x2000	46,00	1830	27,50	3 x 4,00	27,94	
	2030x2000	61,00	2330	35,00	4 x 4,00	27,59	

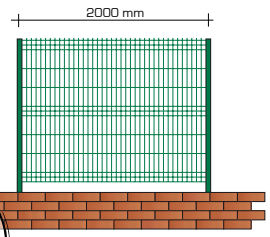

PANNELLO "VILLA CORTO" maglia 200x50 filo 4/4 interasse 2000 VERDE RAL 6005

Codice	Pannello		Palo cementato 60x60x1,50		Fissaggio	Recinzione	SCONTO
	H x L mm	Costo €/cad	Altezza mm	Costo €/cad	Costo €	completa €/mq	
	830x2000	21,50	1130	17,00	2 x 4,00	28,10	
	1030x2000	23,00	1350	20,00	2 x 4,00	24,76	
	1230x2000	26,50	1530	23,00	2 x 4,00	23,37	
	1530x2000	34,50	1830	27,50	3 x 4,00	24,19	
	1730x2000	37,00	2000	30,00	3 x 4,00	22,83	
	2030x2000	44,00	2330	35,00	4 x 4,00	23,40	

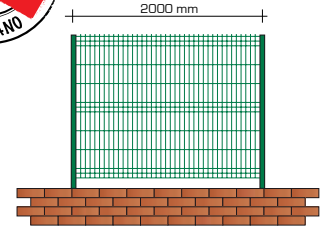

PALO QUADRO 60x60x1,50 CON PIASTRA VERDE RAL 6005

Codice	H mm	€/pz	Fissaggio verde RAL 6005	SCONTO
	870	20,00	completo di bulloni	€/cad
	1070	24,00	intermedio	4,00
	1270	27,00		
	1570	33,00	finale	4,00
	1770	36,00		
	2070	42,00	angolo	4,20

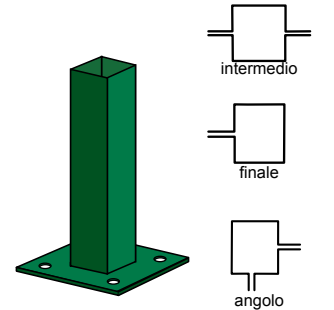

PALO TONDO 48 CON PIASTRA VERDE RAL 6005

Codice	H mm	€/pz	Fissaggio verde RAL 6005	SCONTO
	870	11,50	completo di bulloni	€/cad
	1070	13,80	intermedio	3,80
	1270	15,60		
	1570	18,60		
	1770	20,50		
	2070	24,00		

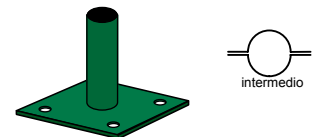

PALO TONDO 48 SENZA PIASTRA VERDE RAL 6005

Codice	H mm	€/pz	Fissaggio verde RAL 6005	SCONTO
	1130	9,60	completo di bulloni	€/cad
	1350	11,50	intermedio	3,80
	1530	13,00		
	1830	15,50		
	2000	17,00		
	2330	20,00		



Listino prezzi OTTOBRE 2014

RECINZIONI FISSE

PANNELLO "STANDARD" maglia 200x50 filo 5/5 interasse 2500 GRIGIO MICACEO

Codice	Pannello		Palo 60x60x1,50		Fissaggio	Recinzione	SCONTO
	H x L	Costo	Altezza	Costo	Costo	completa	
	mm	€/cad	mm	€/cad	€	€/mq	
	830x2500	36,85	1130	18,60	2 x 4,00	30,55	
	1030x2500	41,80	1350	22,50	2 x 4,00	28,08	
	1230x2500	50,60	1530	25,50	2 x 4,00	27,35	
	1530x2500	62,15	1830	30,20	3 x 4,00	27,28	
	1730x2500	69,00	2000	33,00	3 x 4,00	26,36	
	2030x2500	83,00	2330	38,50	4 x 4,00	27,09	

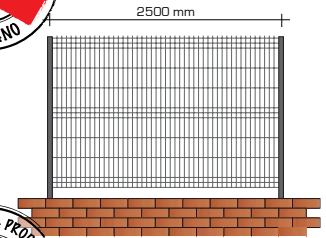

PANNELLO "CORTO" L 2000 - filo 5/5 - maglia 200x50 - GRIGIO MICACEO

Codice	Pannello		Palo 60x60x1,50		Fissaggio	Recinzione	SCONTO
	H x L	Costo	Altezza	Costo	Costo	completa	
	mm	€/cad	mm	€/cad	€	€/mq	
	830x2000	31,00	1130	18,60	2 x 4,00	34,70	
	1030x2000	34,00	1350	22,50	2 x 4,00	31,31	
	1230x2000	40,70	1530	25,50	2 x 4,00	30,16	
	1530x2000	50,60	1830	30,20	3 x 4,00	30,33	
	2030x2000	67,00	2330	38,50	4 x 4,00	29,93	

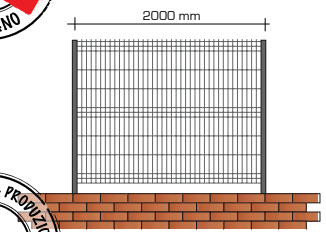

PANNELLO "CORTO" L 2000 - filo 4/4 - maglia 200x50 - GRIGIO MICACEO

Codice	Pannello		Palo 60x60x1,50		Fissaggio	Recinzione	SCONTO
	H x L	Costo	Altezza	Costo	Costo	completa	
	mm	€/cad	mm	€/cad	€	€/mq	
	830x2000	23,80	1130	18,60	2 x 4,00	30,40	
	1030x2000	25,30	1350	22,50	2 x 4,00	25,15	
	1230x2000	29,15	1530	25,50	2 x 4,00	25,47	
	1530x2000	38,00	1830	30,20	3 x 4,00	26,21	
	1730x2000	40,70	2000	33,00	3 x 4,00	24,77	
	2030x2000	48,50	2330	38,50	4 x 4,00	25,37	

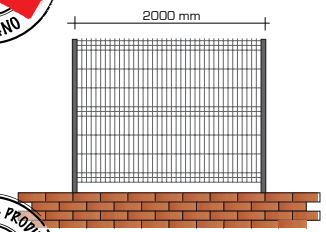

PANNELLO "STANDARD" L 2500 - filo 5/5 - maglia 200x50 - ZINCATI

Codice	Pannello		Palo 60x60x1,50		Fissaggio	Recinzione	SCONTO
	H x L	Costo	Altezza	Costo	Costo	completa	
	mm	€/cad	mm	€/cad	€	€/mq	
	830x2500	25,00	1130	9,60	2 x 4,00	20,53	
	1030x2500	30,00	1350	11,50	2 x 4,00	19,22	
	1230x2500	35,00	1530	13,00	2 x 4,00	18,21	
	1530x2500	45,00	1830	15,50	3 x 4,00	18,96	
	1730x2500	50,00	2000	17,00	3 x 4,00	18,27	
	2030x2500	58,00	2330	20,00	4 x 4,00	18,52	

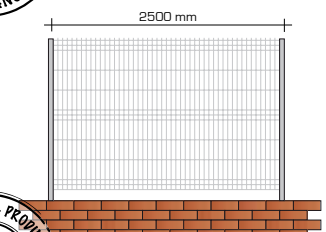

PANNELLO "CORTO" L 2000 - filo 5/5 - maglia 200x50 - ZINCATI

Codice	Pannello		Palo 60x60x1,50		Fissaggio	Recinzione	SCONTO
	H x L	Costo	Altezza	Costo	Costo	completa	
	mm	€/cad	mm	€/cad	€	€/mq	
	830x2000		1130	9,60	2 x 4,00		
	1030x2000	25,00	1350	11,50	2 x 4,00	21,60	
	1230x2000	30,00	1530	13,00	2 x 4,00	20,73	
	1530x2000	36,50	1830	15,00	3 x 4,00	20,75	
	2030x2000	49,00	2330	20,00	4 x 4,00	20,94	

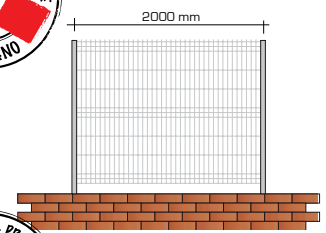

PANNELLO "CORTO" L 2000 - filo 4/4 - maglia 200x55 - ZINCATI

Codice	Pannello		Palo 60x60x1,50		Fissaggio	Recinzione	SCONTO
	H x L	Costo	Altezza	Costo	Costo	completa	
	mm	€/cad	mm	€/cad	€	€/mq	
	830x2000		1130	9,60	2 x 4,00		
	1030x2000	15,00	1350	11,50	2 x 4,00	16,75	
	1230x2000	17,70	1530	13,00	2 x 4,00	15,73	
	1530x2000	22,50	1830	15,50	3 x 4,00	16,34	
	1730x2000	25,00	2000	17,00	3 x 4,00	15,75	
	2030x2000	30,00	2330	20,00	4 x 4,00	16,26	

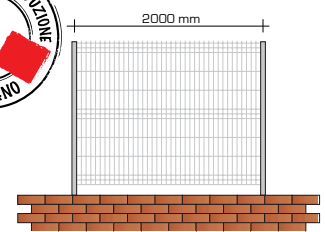

Cancello pedonale zincato e plastificato modello "Villa" - confezione 1 pz in cartone

Codice		LARGHEZZA	ALTEZZA	PREZZO	SCONTO
		CM	CM	EURO/PZ	
CANC VILLA STAND 150	Modello Standard	100	150	340,00	
CANC VILLA STAND 175		100	175	400,00	
CANC VILLA STAND 200		100	200	460,00	
colore	verde - RAL6005				
				Euro / Mq	
FUORI STANDARD		su misura	su misura	440,00	
colore SU RICHIESTA					

Cancello a 2 ante zincato e plastificato modello "Villa" - confezione su richiesta

Codice		LARGHEZZA	ALTEZZA	PREZZO	SCONTO
		CM	CM	EURO/mq	
CANC VILLA 2 ANTE	colore	*	*	360,00	
colore	verde - RAL6005				
				Euro / Mq	
FUORI STANDARD	colore	su misura	su misura	380,00	
colore SU RICHIESTA	su richiesta				

Cancello scorrevole zincato e plastificato modello "Villa"

Codice		LARGHEZZA	ALTEZZA	PREZZO	SCONTO
		CM	CM	EURO/mq	
CANC VILLA SCOR	colore	*	*	340,00	
colore	verde - RAL6005				
				Euro / Mq	
FUORI STANDARD	colore	su misura	su misura	360,00	
colore SU RICHIESTA	su richiesta				

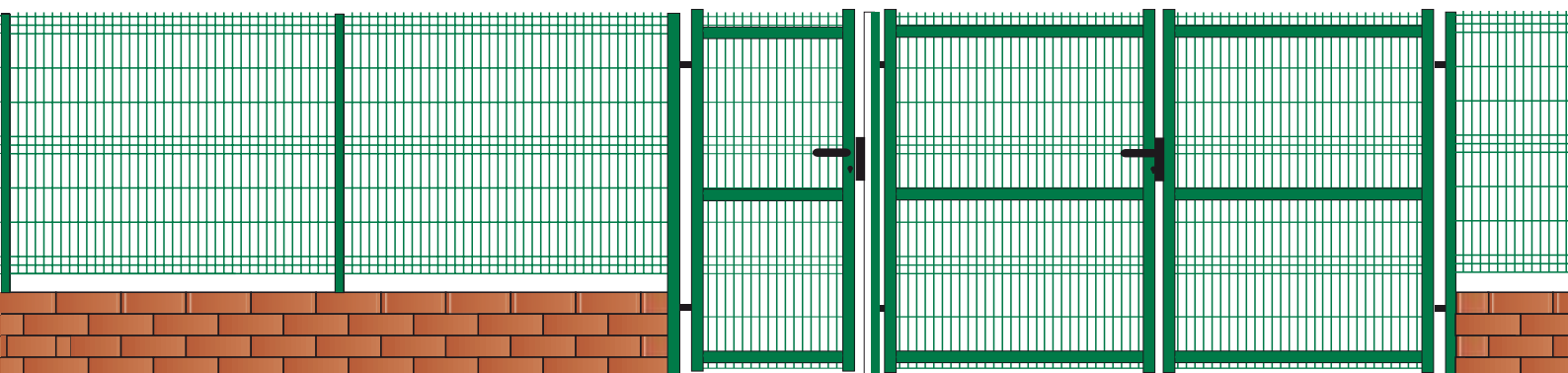
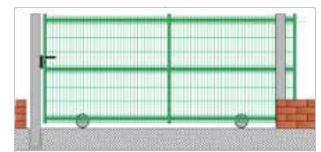
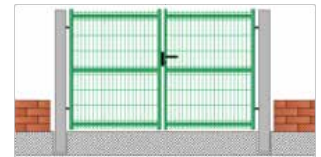

Grigliato Elettrosaldato Zincato a caldo

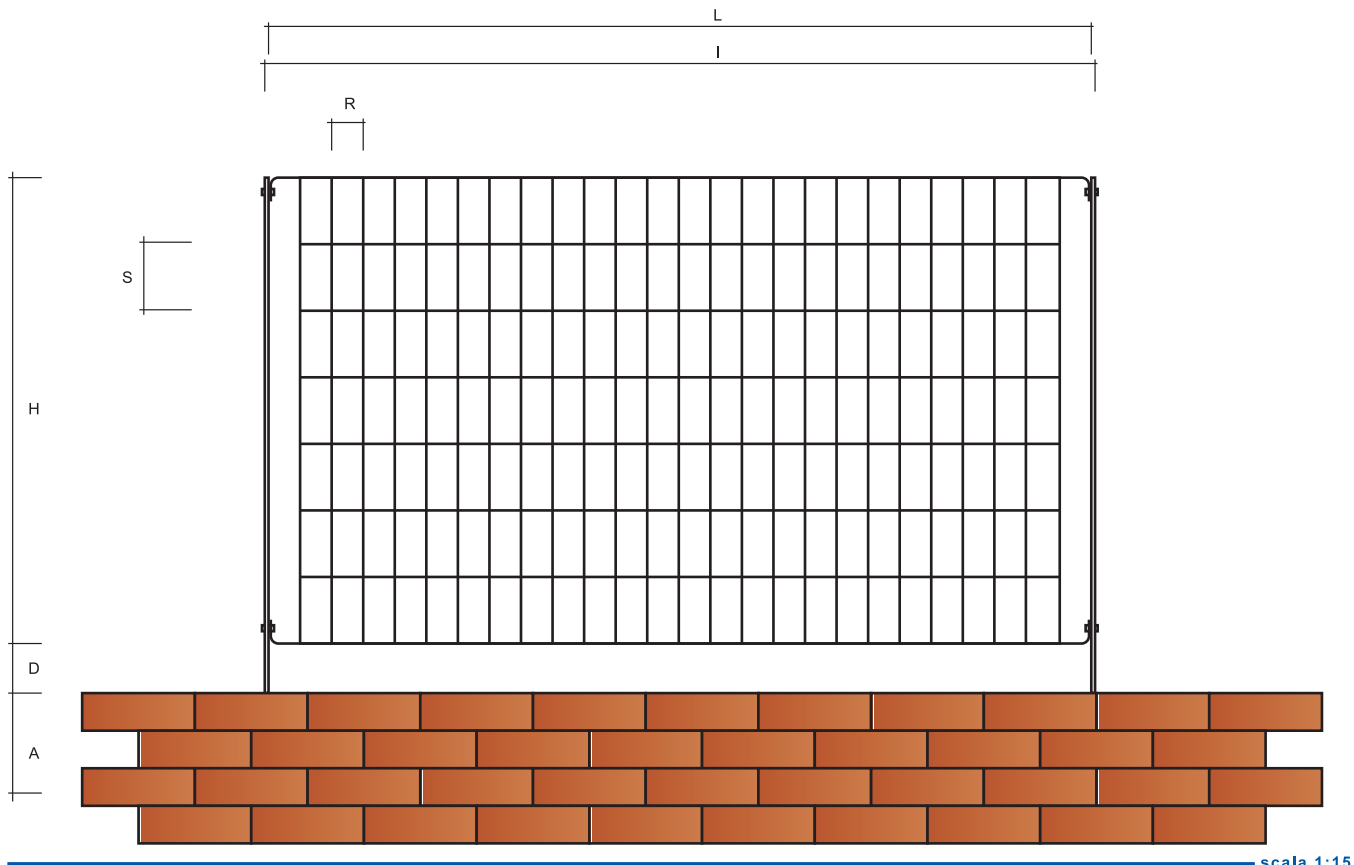

scala 1:15

Sistemi di Fissaggio del montante.

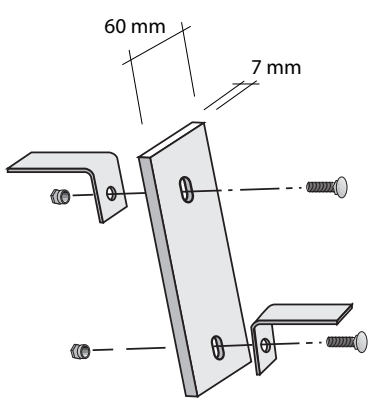
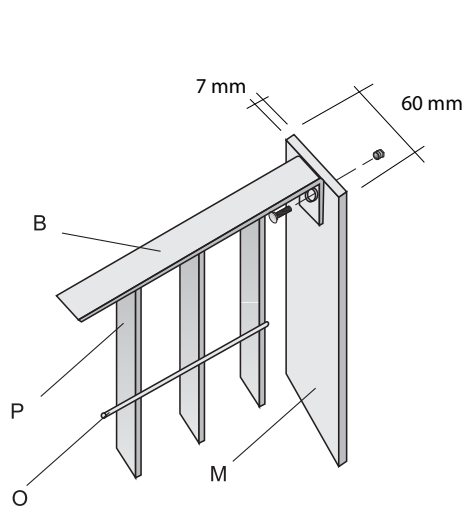

Montanti con doppia foratura per tratti in pendenza



Bullone inox sicurezza a strappo zincato

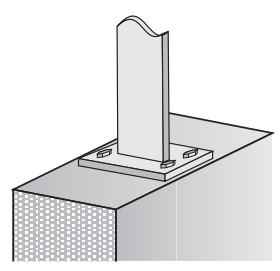

con piastra

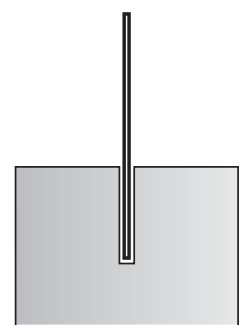

cementato

GRIGLIATO elettrosaldato zincato a caldo Maglia 62x132 - Piatto 25x2 - interasse 2000

Codice	Pannello	Piatto	Piantana da cementare		Bullone	Recinzione	SCONTO
	HxL	25x2	H	≠	Inox 10x30	completa	
	mm	€/cad	mm	€/cad	€/cad	€/mq	
	930x1992	48,62	1200	60x7	11,12	2 x 0,80	33,11
	1200x1992	57,47	1500	60x7	13,50	2 x 0,80	30,86
	1326x1992	62,00	1600	60x7	14,32	2 x 0,80	29,50
	1460x1992	66,54	1800	60x7	15,55	2 x 0,80	28,78
	1722x1992	75,50	2000	60x7	17,51	2 x 0,80	27,58
	1988x1992	84,46	2400	60x7	21,73	2 x 0,80	27,22
	2118x1992	90,12	2500	80x8	34,61	2 x 0,80	29,94

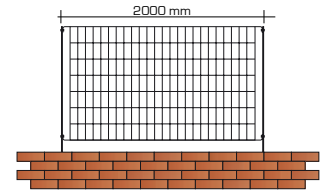
**GRIGLIATO elettrosaldato zincato a caldo Maglia 62x132 - Piatto 25x3 - interasse 2000**

Codice	Pannello	Piatto	Piantana da cementare		Bullone	Recinzione	SCONTO
	HxL	25x3	H	≠	Inox 10x30	completa	
	mm	€/cad	mm	€/cad	€/cad	€/mq	
	930x1992	63,14	1200	60x7	11,12	2 x 0,80	40,95
	1200x1992	76,12	1500	60x7	13,50	2 x 0,80	38,16
	1326x1992	83,12	1600	60x7	14,32	2 x 0,80	37,50
	1460x1992	89,71	1800	60x7	15,55	2 x 0,80	36,74
	1722x1992	103,51	2000	60x7	17,51	2 x 0,80	35,75
	1988x1992	117,73	2400	60x7	21,73	2 x 0,80	35,62
	2118x1992	125,76	2500	80x8	34,61	2 x 0,80	38,39

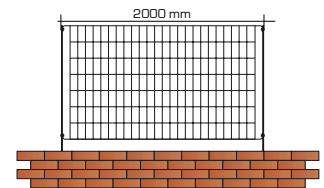
**GRIGLIATO elettrosaldato zincato a caldo Maglia 62x132 - Piatto 25x2 - interasse 1650**

Codice	Pannello	Piatto	Piantana da cementare		Bullone	Recinzione	SCONTO
	HxL	25x2	H	≠	Inox 10x30	completa	
	mm	€/cad	mm	€/cad	€/cad	€/mq	
	930x1642	48,72	1200	60x7	11,34	2 x 0,80	40,40
	1200x1642	57,43	1500	60x7	13,50	2 x 0,80	36,80
	1326x1642	61,42	1600	60x7	14,32	2 x 0,80	35,50
	1460x1642	65,52	1800	60x7	15,55	2 x 0,80	34,50
	1722x1642	73,50	2000	60x7	17,51	2 x 0,80	32,80
	1988x1642	81,69	2400	60x7	21,73	2 x 0,80	32,20
	2118x1642	88,62	2500	80x8	34,61	2 x 0,80	35,90

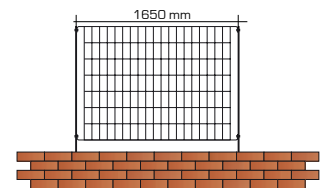
**GRIGLIATO elettrosaldato zincato a caldo Maglia 62x132 - Piatto 25x3 - interasse 1650**

Codice	Pannello	Piatto	Piantana da cementare		Bullone	Recinzione	SCONTO
	HxL	25x3	H	≠	Inox 10x30	completa	
	mm	€/cad	mm	€/cad	€/cad	€/mq	
	930x1642	62,16	1200	60x7	11,12	2 x 0,80	48,83
	1200x1642	74,02	1500	60x7	13,50	2 x 0,80	45,03
	1326x1642	79,90	1600	60x7	14,32	2 x 0,80	43,82
	1460x1642	75,39	1800	60x7	15,55	2 x 0,80	38,41
	1722x1642	97,54	2000	60x7	17,51	2 x 0,80	41,07
	1988x1642	109,41	2400	60x7	21,73	2 x 0,80	40,47
	2118x1642	118,12	2500	80x8	34,61	2 x 0,80	44,09

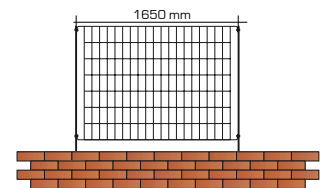
**ACCESSORI e TRATTAMENTI**

Codice	Piantane con piastre			Aletta di compensazione		SCONTO
	H mm	≠	€/cad	Zincata	€/cad	
	1000	60x7	14,52			3,00
	1250	60x7	16,89			
	1400	60x7	17,72			
	1510	60x7	18,95			
	1810	60x7	20,90	Extra per verniciatura e poliestre		
	2040	60x7	25,13		€/mq	16,00

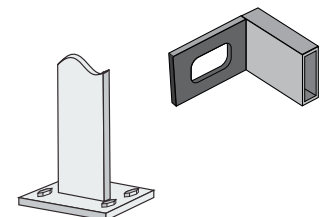

CANCELLI SCORREVOLI IN GRIGLIATO - TIPO LEGGERO ZINCATO A CALDO

	largh	lune netta	Altezza	Pilastr	Telaio	Zoccolo	Grigliato	Zincato	SCONTO
Codice	mm	mm	mm	mm	mm	mm	mm	€/cad	
	4000	3800	2000	100x100x3	100x50x3	100x50x3	62x132-25x2	*	
	4000	3800	2300	100x100x3	100x50x3	100x50x3	62x132-25x2	*	
	5000	4800	2000	100x100x3	100x50x3	100x50x3	62x132-25x2	*	
	5000	4800	2300	100x100x3	100x50x3	100x50x3	62x132-25x2	*	

CANCELLI SCORREVOLI IN GRIGLIATO - TIPO PESANTE ZINCATO A CALDO

	largh	lune netta	Altezza	Pilastr	Telaio	Zoccolo	Grigliato	Zincato	SCONTO
Codice	mm	mm	mm	mm	mm	mm	mm	€/cad	
	6000	5800	2000	100x100x3	120x60x3	120x60x3	62x132-25x2	*	
	6000	5800	2300	100x100x3	120x60x3	120x60x3	62x132-25x2	*	
	7000	6800	2000	100x100x3	120x60x3	120x60x3	62x132-25x2	*	
	7000	6800	2300	100x100x3	120x60x3	120x60x3	62x132-25x2	*	
	8000	7800	2000	100x100x3	120x60x3	120x60x3	62x132-25x2	*	
	8000	7800	2300	100x100x3	120x60x3	120x60x3	62x132-25x2	*	

CANCELLI DUE ANTE IN GRIGLIATO ZINCATO A CALDO

	largh	lune netta	Altezza	Pilastr	Telaio	Zoccolo	Grigliato	Zincato	SCONTO
Codice	mm	mm	mm	mm	mm	mm	mm	€/cad	
	3000	2800	2000	100x100x3	100x50x3	100x50x3	62x132-25x2	*	
	3000	2800	2300	100x100x3	100x50x3	100x50x3	62x132-25x2	*	
	4000	3800	2000	100x100x3	100x50x3	100x50x3	62x132-25x2	*	
	4000	3800	2300	100x100x3	100x50x3	100x50x3	62x132-25x2	*	
	5000	4800	2000	100x100x3	100x50x3	100x50x3	62x132-25x2	*	
	5000	4800	2300	100x100x3	100x50x3	100x50x3	62x132-25x2	*	

CANCELLI AD UN'ANTA IN GRIGLIATO ZINCATO A CALDO

	largh	lune netta	Altezza	Pilastr	Telaio	Zoccolo	Grigliato	Zincato	SCONTO
Codice	mm	mm	mm	mm	mm	mm	mm	€/cad	
	1000	800	2000	100x100x3	100x50x3	100x50x3	62x132-25x2	*	
	1000	800	2300	100x100x3	100x50x3	100x50x3	62x132-25x2	*	
	1200	1000	2000	100x100x3	100x50x3	100x50x3	62x132-25x2	*	
	1200	1000	2300	100x100x3	100x50x3	100x50x3	62x132-25x2	*	

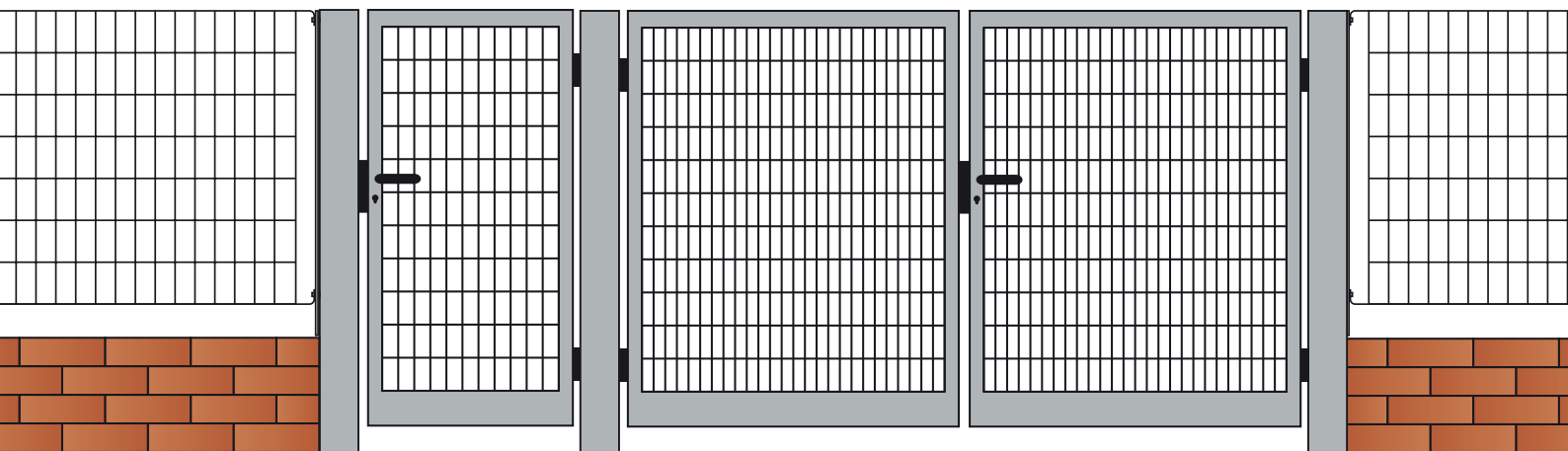
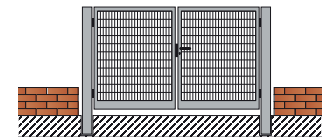
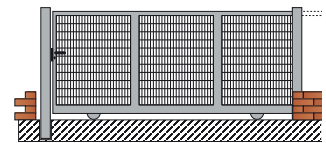
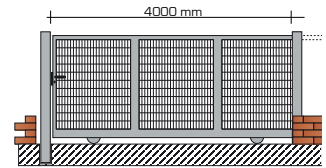

RETE ELETTROSALDATA SIDERURGICA in filo lucido - confezioni da 50 pz

Codice	Dimensioni mm	Maglia mm	Filo		NERA PREZZO EURO/KG	SCONTO
			N°	mm		
RE2400X1200F2M30X30	2400x1200	30x30	17	3	23,05	
RE2400X1200F4M40X40	2400x1200	40x40	19	4	29,58	
RE2400X1200F3M50X50	2400x1200	50x50	17	3	16,72	
RE2400X1200F4M50X50	2400x1200	50x50	19	4	22,64	
RE2400X1200F5M50X50	2400x1200	50x50	21	5	40,18	

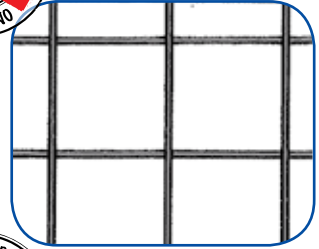

RETE ELETTROSALDATA SIDERURGICA in filo zincato - confezioni da 50 pz

Codice	Dimensioni mm	Maglia mm	Filo		PREZZO EURO/KG	SCONTO
			N°	mm		
REZ2400X1200F2M30X30	2400x1200	30x30	17	2	25,50	
REZ2400X1200F4M40X40	2400x1200	40x40	19	4	32,64	
REZ2400X1200F3M50X50	2400x1200	50x50	17	2	16,83	
REZ2400X1200F4M50X50	2400x1200	50x50	19	4	25,19	
REZ2400X1200F5M50X50	2400x1200	50x50	21	5		

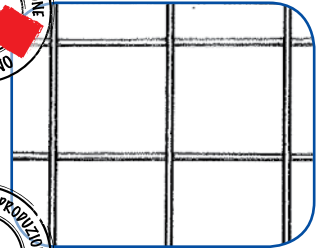

RETE ANTINFORTUNISTICA in filo lucido - confezioni da 50 pz

Codice	Dimensioni mm	Maglia mm	Filo		PREZZO EURO/KG	SCONTO
			N°	mm		
RA2400X1200F3M60X11	2400x1200	60X11	17	3	40,18	
RA2400X1200F3M105X15	2400x1200	105X15	17	3	33,05	

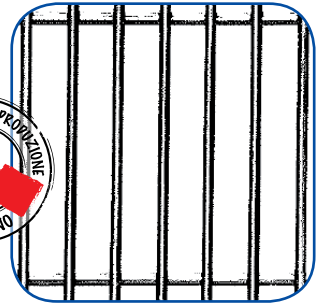

RETE ANTINFORTUNISTICA ZINCATA in filo zincato crudo

Codice	Dimensioni mm	Maglia mm	Filo		PREZZO EURO/KG	SCONTO
			N°	mm		
RAF2400X1200F3M60X11	2400x1200	60X11	17	3	42,30	
RAF2400X1200F3M105X15	2400x1200	105X15	17	3	35,50	

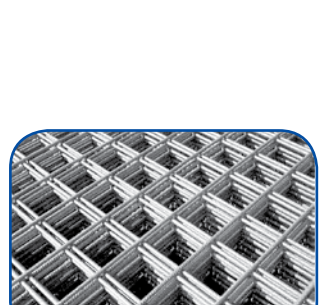

RETE ELETTROSALDATA x C.A. in filo lucido Aderenza migliorata

Codice	dimensione pannello	Maglia Long	Filo		PREZZO EURO/KG	SCONTO
			N°	mm		
RE100X100F5	2000x3000	100x100		5	*	
RE150X150F5	2000x3000	150x150		5	*	
RE200X200F5	2000x3000	200x200		5	*	
RE100X100F6	2000x3000	100x100		6	*	
RE150X150F6	2000x3000	150x150		6	*	
RE200X200F6	2000x3000	200x200		6	*	
RE100X100F8	2000x3000	100x100		8	*	
RE150X150F8	2000x3000	150x150		8	*	
RE200X200F8	2000x3000	200x200		8	*	
RE200X200F10	2250x4000	200x200		10	*	
RE200X200F12	2250x4000	200x200		12	*	

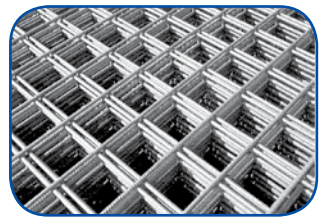

RETE ELETTROSALDATA x C.A. in filo zincato Aderenza migliorata

Codice	dimensione pannello	Maglia Long	Filo		PREZZO EURO/KG	SCONTO
			N°	mm		
REZ100X100F5	2000x3000	100x100		5	*	
REZ150X150F5	2000x3000	150x150		5	*	
REZ200X200F5	2000x3000	200x200		5	*	
REZ100X100F6	2000x3000	100x100		6	*	
REZ150X150F6	2000x3000	150x150		6	*	
REZ200X200F6	2000x3000	200x200		6	*	



Listino prezzi OTTOBRE 2014



LAMIERE ONDULATE ZINCATE - confezioni in pacchi da 400 pz

mt 2 - 2,5 - 3 x 0,90					PREZZO	SCONTO
Codice	n.	Spessore	Kg/ml	EURO/KG		
LO0,25	32	0,25	1,96	2,30		
LO0,30	30	0,30	2,36	2,20		

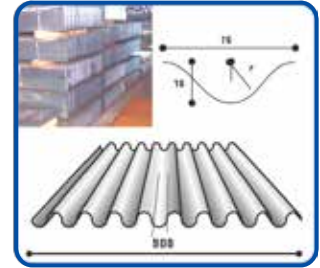

LAMIERE GREGATE ZINCATE - confezioni da 50 pz

mt. 3 - 4 - 5 - 6 - 7 - 8 oppure taglio a misura					PREZZO	SCONTO
Codice	Spessore mm.		Kg/ml	EURO/KG		
LGZ0,5	0,5		4,9	2,00		
LGZ0,6	0,6		5,88	1,90		
LGZ0,7	0,7		6,89	1,85		



LAMIERE GREGATE PREVERNICIATE

mt. 3 - 4 - 5 - 6 - 7 - 8 oppure taglio a misura					PREZZO	SCONTO
Codice	Spessore mm.		Kg/ml	EURO/KG		
LGP0,5	0,5			*		
LGP0,6	0,6			*		

PANNELLI COIBENTATI PER COPERTURE - confezioni su richiesta

mt. 2 - 3 - 4 - 5 - 6 - 7 - 8 - 9 - 10 - 11 - 12 - 13 oppure taglio a misura					PREZZO	SCONTO
Codice	Spessore mm		Kg/m2	EURO/MQ		
LAMCOIB30	30			*		
LAMCOIB40	40			28,00		
LAMCOIB50	50			*		
LAMCOIB60	60			*		
LAMCOIB80	80			*		

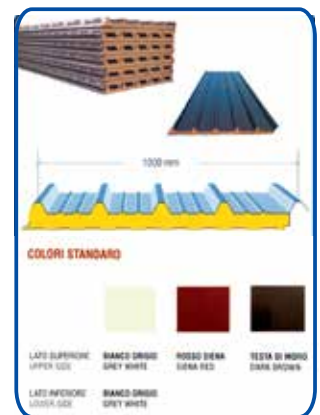

COPPO PANNELLI COIBENTATI

mt 3,075 - 4,1 - 5,135 - 6,15 - 7,17 - 8,2 - 10,25 - 12,3 - 12,64 oppure taglio a misura					PREZZO	SCONTO
Codice	Spessore mm		Kg/m2	EURO/MQ		
COPPO80	80			55,00		

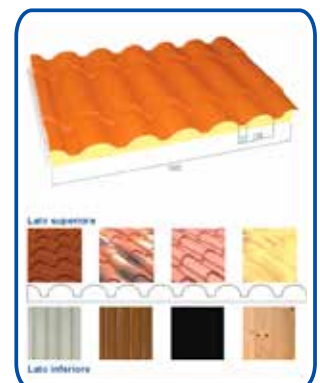

CONTATTI

Note:

Quando trovate l'asterisco *

per sapere il prezzo e la disponibilità chiedete al nostro rappresentante di zona

Sig. _____ Tel. _____

oppure inviate un Fax allo **0825 892635**

o contattate i nostri Uffici:

Ufficio Commerciale

Tel. 0825 892171 int. 200

Tel. 0825 891107 int. 103

Tel. 0825 892127 int. 201

Teresa Paoletta

Raffaella Masuccio

Antonella Piccirillo

teresa.paoletta@irpina.com

raffaella.masuccio@irpina.com

antonella.piccirillo@irpina.com

Ufficio Spedizioni/Logistica

Tel. 0825 892500 int. 203

int. 205

int. 213

int. 214

Luana Di Maina

Antonietta Lo Conte

Antonio Maraia

Antonio Sicuriello

luana.dimaina@irpina.com

antonietta.loconte@irpina.com

spedizioni@irpina.com

antonio.sicuriello@irpina.com

Ufficio Magazzino

Tel. 0825 892500 int. 213

Domenico Molinaro

Dante Molinaro

domenico.molinaro@irpina.com

magazzino@irpina.com

Ufficio Contabilità / Amministrazione

Tel. 0825 892970 int. 105

int. 204

int. 202

Antonietta Cusano

Rosaria De Donato

Debora Bongo

antonietta.cusano@irpina.com

rosaria.dedonato@irpina.com

debora.bongo@irpina.com

Ufficio Estero

Tel. 0825 892970 int. 102

int. 104

Li Xinqiao (Angela)

Raymonde Coniglio

li.xinqiao@irpina.com

raymonde.coniglio@irpina.com

per qualsiasi informazione
o altro non esitate a contattarci:

grazie per averci preferito

Giancarlo Molinaro

giancarlo.molinaro@irpina.com

CONDIZIONI DI VENDITA

In riferimento agli ordini trasmessi, si accettano le seguenti condizioni:

- 1) Il presente listino annulla e sostituisce tutti i precedenti e resterà valido fino ad eventuale variazione (deroghe saranno ammesse solo se precisate negli ordini);
- 2) **I prezzi di vendita saranno al netto dell'IVA e franco partenza nostri stabilimenti e/o magazzini;**
- 3) Il costo del trasporto andrà concordato ed indicato nell'ordine;
- 4) Gli ordini dovranno inoltre riportare la descrizione dell'articolo completo di codice e s'intenderanno sempre "SALVO APPROVAZIONE DELLA CASA";
- 5) Gli imballi verranno forniti gratuitamente, quelli "speciali" dovranno essere richiesti al momento dell'ordine e fatturati al prezzo concordato;
- 6) Il destinatario è obbligato al controllo della merce annotando sul D.D.T., insieme al vettore, eventuali differenze e/o anomalie riscontrate;
- 7) I termini di consegna si intendono sempre "salvo imprevisti" ed eventuali ritardi non determineranno, in nessun caso, penalità salvo se concordate in fase d'ordine;
- 8) I termini e le modalità di pagamento saranno quelle pattuite in fase d'ordine.
In caso di ritardato pagamento sarà applicata un'indennità di mora pari al tasso di rifinanziamento della B.C.E. maggiorato di 8 punti percentuali come previsto dal Dlg.231/2002.
Trascorsi comunque 15 giorni dall'insoluto o dal mancato pagamento, la pratica passerà automaticamente, **senza nessun avviso**, alla società di assicurazione del credito con la quale abbiamo assicurato la clientela e/o ad un'agenzia di recupero crediti e/o al nostro legale di fiducia;
- 9) Dati tecnici, pesi, dimensioni e illustrazioni riportati sia nel presente listino e che nei cataloghi sono puramente indicativi e non sono assolutamente impegnativi.
A tal proposito ci riserviamo la facoltà di modificarli, per aggiornamenti tecnici e/o esigenze produttive, in qualsiasi momento e senza preavviso;
- 10) In caso di controversia, si elegge unico foro competente Benevento (Bn).

Con il **FILO**
del **BUONSENSO...**
abbiamo creato
una **RETE** presente
in tutta **ITALIA**

GROSSETO

TERAMO

LUCERA

AVELLINO

CAGLIARI

CALTANISSETTA

Metallurgica Irpina spa

FILO ZINCATO - PALETTI - RETI METALLICHE



Via Fontana Angelica, 1 • 83031 ARIANO IRPINO (AV)
P. IVA 02080610641 • C.C.I.A.A. di Avellino N° 161253/1997 • R.E.A. N° 134514
Tel. +39 0825 892171 • +39 0825 892970 • Fax +39 0825 892635
metallurgica@irpina.com

Irpina

DISTRIBUZIONE



Via Torreamando, 108 • 83031 ARIANO IRPINO (AV)
P. IVA 02596760641 • C.C.I.A.A. di Avellino N° 02596760641 • REA n. 169350
Tel. +39 0825 891107 • +39 0825 892500 • Fax +39 0825 892635
distribuzione@irpina.com